



Teileliste und Näheinrichtungen
Spare Parts List and Sewing Equipment

467- 65

DÜRKOPP ADLER AG

Postfach 17 03 51, D-33703 Bielefeld • Potsdamer Straße 190, D-33719 Bielefeld
Telefon (05 21) 9 25-0 • Telefax (05 21) 9 25 24 35

Ausgabe / Edition: 01/2000 • DO

Printed in Federal Republic of Germany

Teile-/Part.-No.: 0791 467803

Erläuterungen zur Ersatzteilleiste

1. Allgemeines

Separate Ersatzteilleisten gibt es fuer : N a e h g a r n i t u r e n, Naehkopfabhaengige Zusatzausstattungen.

2. Kennzeichnung der Ersatzteile

Zu einer Einheit gehoernde Einzelteile sind durch eine strichpunktierte Linie eingerahmt. Die Einheit kann auch komplett unter der voll eingerahmten Nr. (in einem Kasten) bestellt werden. Zu dieser Einheit gehoeren keine Teile, deren Nr. ausserhalb der strichpunktierten Linie steht.

Teile, die mit "N" gekennzeichnet sind, werden nicht einzeln geliefert.

Sollten Sie ein Teil nicht in der Ersatzteilleiste auffinden, was durch technische Aenderungen vorkommen kann, dann geben Sie uns bitte zur Teile- und Funktionsbeschreibung die genaue Unterklasse und Fabrik-Nr. lt. Typenschild bekannt.

Bei Bestellungen von Elektroteilen bitten wir die zusaetzlichen Angaben, die in Klammern hinter der Teile-Nr. stehen, mit anzugeben.

Im Inhaltsverzeichnis sind die Teile-Nr. nach steigenden Nr. geordnet. Ausserdem sind angegeben :

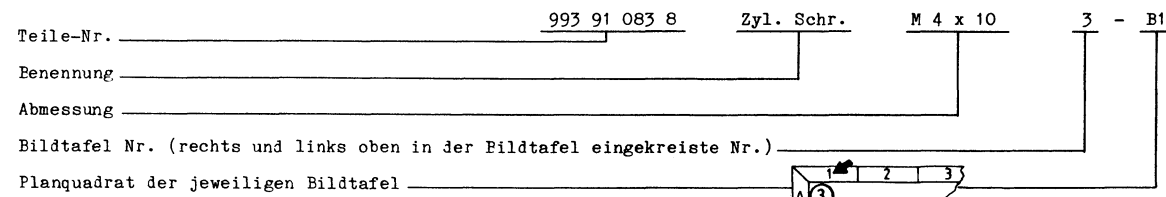

3. Verwendete Bildzeichen

	= siehe Mechanikeranleitung		= ohne Fadenabschneider		= Hinweis auf Unterscheidungsmerkmal		= 1 Nadel
	= fluessig sichern, kleben, dichten Loctite 270, Nr. 990 49 034 6		= mit Fadenabschneider	mm	= Maße		= 2 Nadeln
	= fluessig sichern, kleben, dichten Loctite IS-460, Nr. 990 49 037 1		= links	V	= veraltete Ausfuehrung		
	= Laenge oder Flaechen angeben		= rechts	a.W.	= auf Wunsch		

4. Handhabung der Ersatzteilleiste

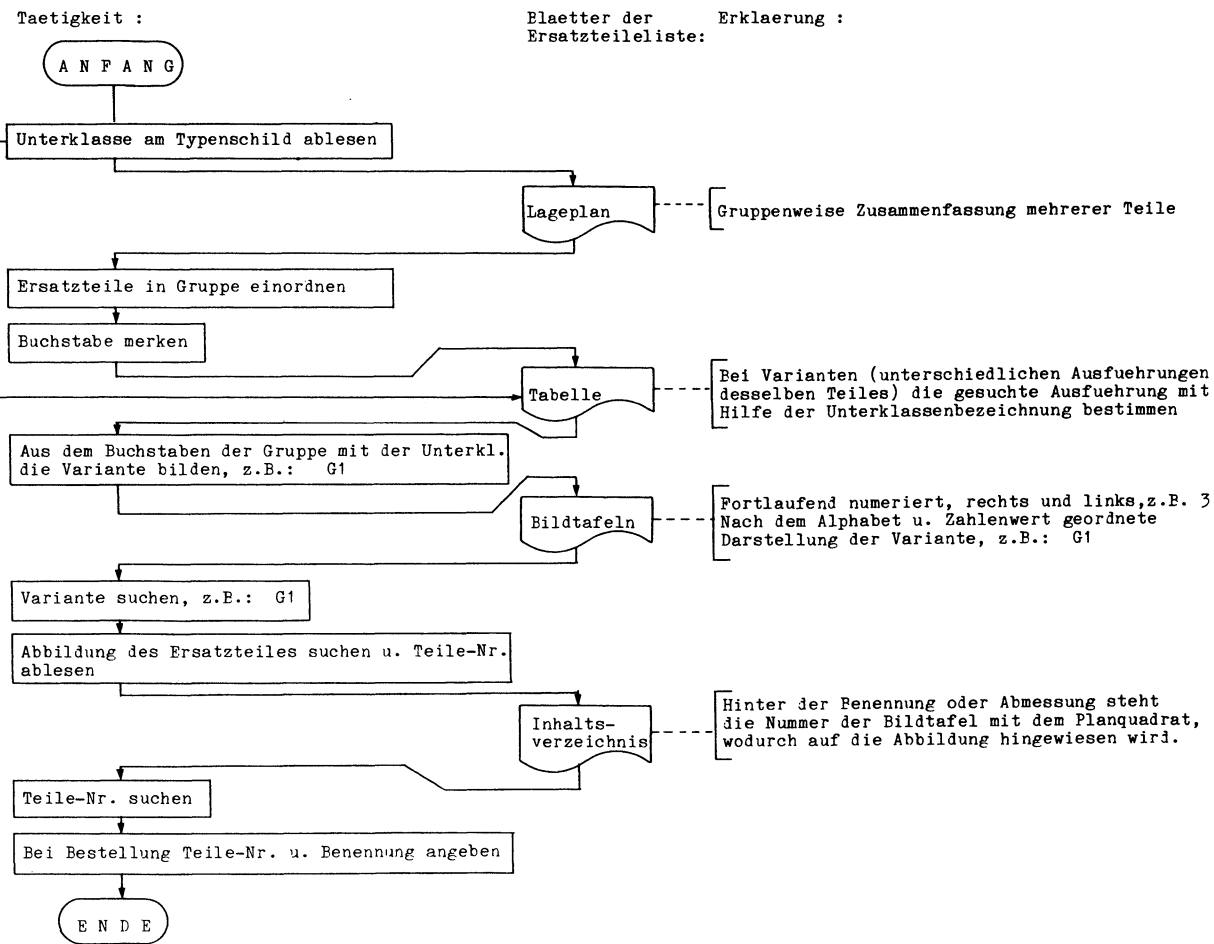

5. Jeder Nachdruck, auch auszugsweise, ist nur mit unserer Genehmigung gestattet. Aenderungen behalten wir uns vor.

Explanation of spare parts list

1. In general

Separate lists are available for sewing components, s e w i n g - m a c h i n e dependent additional equipment.

2. Numbering of parts

The component parts of a complete unit are framed by a dot-dash line. The unit can also be ordered complete by quoting the number enclosed in the full lined "box" contained within the dot-dash frame. Any parts, the numbers of which are outside of the frame, are not part of the unit and must be ordered separately.

Parts marked with "N" cannot be supplied singly.

If a part cannot be found in the parts list, possibly due to technical alteration, when ordering, please describe the part and function fully, quoting the sub-class and serial number of the machine according to the specification plate.

When ordering electrical parts, please include the additional information set in brackets after the part number.

In the table of contents the part numbers are listet in numerical order, e.g.

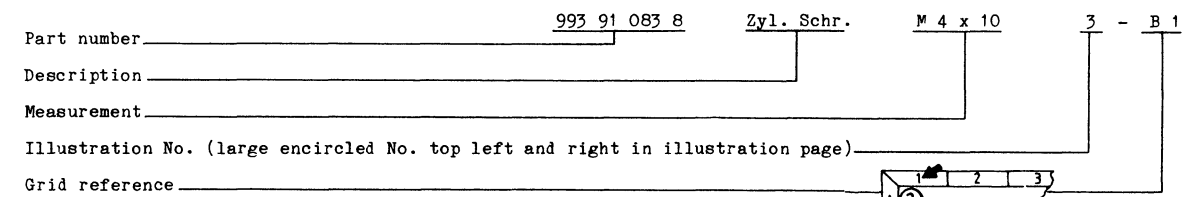

3. Symbols applied

	= see mechanics manual		= without thread cutter		= point of alteration		= 1 needle
	= secure by glueing, seal Loctite 270, No. 990 49 034 6		= with thread cutter	mm	= measurement		= 2 needles
	= secure by glueing, seal Loctite IS-460, No. 990 49 037 1		= left	V	= obsolete		
	= declar length or area		= right	a.W.	= on request		

4. Using the parts list

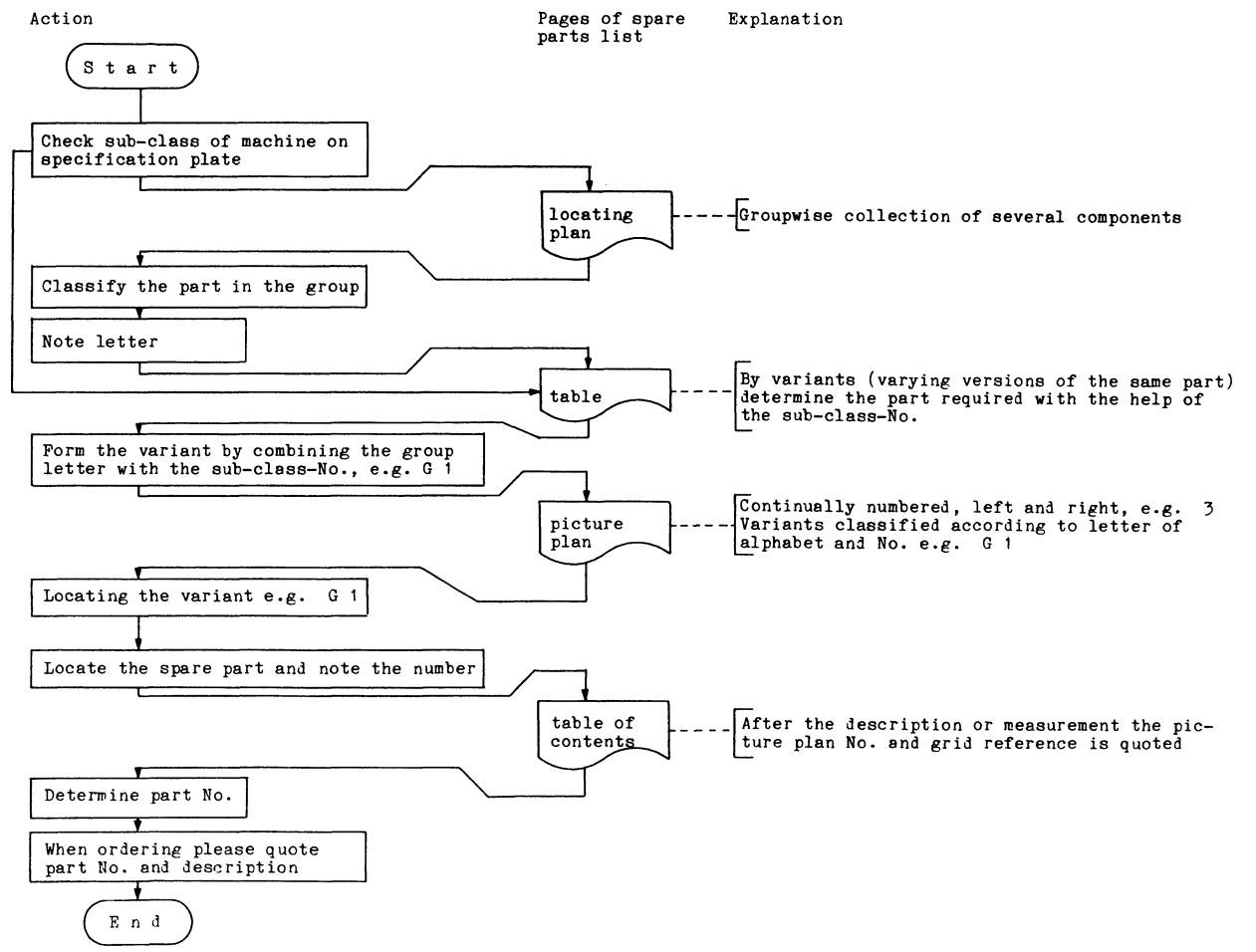

5. All reproductions, also in part, require our permission. Subject to alteration.

Explications pour la liste de pièces de rechange

1. Généralités

Il existe des listes de pièces de rechange séparément pour : jeux de pièces de couture, Equipements supplémentaires dépendant de la machine à coudre

2. Identification des pièces de rechange

Les pièces individuelles faisant partie d'une unité ont été encadrées d'une ligne à point-trait. L'unité peut être commandée aussi sous le numéro complètement encadré. Aucune pièce dont le numéro se trouve en dehors de l'encadrement n'appartient à cette unité.

Les pièces marquées par "N" ne sont pas livrables séparément.

Dans le cas où une pièce de rechange n'est pas indiquée dans la liste de pièces de rechange, ce qui peut se produire au cours de changements techniques, en cas de commande, veuillez indiquer la sous-class exacte ainsi que le numéro de fabrication de la machine selon le matricule.

Dans le cas de commande de pièces électriques veuillez également donner les indications supplémentaires qui se trouvent entre parenthèses après le numéro de la pièce.

Dans le table de matière les numéros des pièces sont indiqués par ordre numérique. En outre sont indiqués :

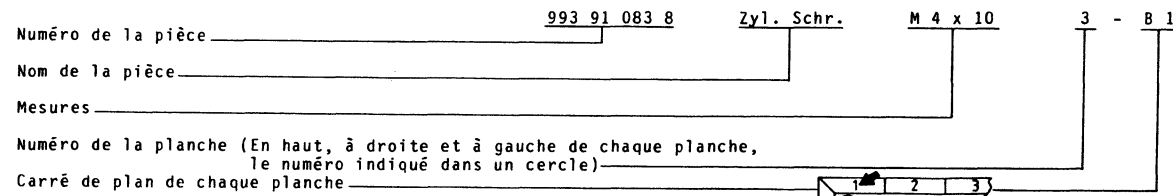

3. Symboles utilisés

- = voir instructions pour le mécanicien
- = coller, fermer hermétiquement Loctite 270, No. 990 49 034 6
- = coller, fermer hermétiquement Loctite IS-460, No. 990 49 037 1
- = indiquer longueur ou surface
- = sans coupe-fil
- = avec coupe-fil
- = gauche
- = droite
- = indication pour point de variation
- = 1 aiguille
- = 2 aiguilles
- = mesures
- = ancien model
- = sur demande

4. Emploi correct de la liste de pièces de rechange

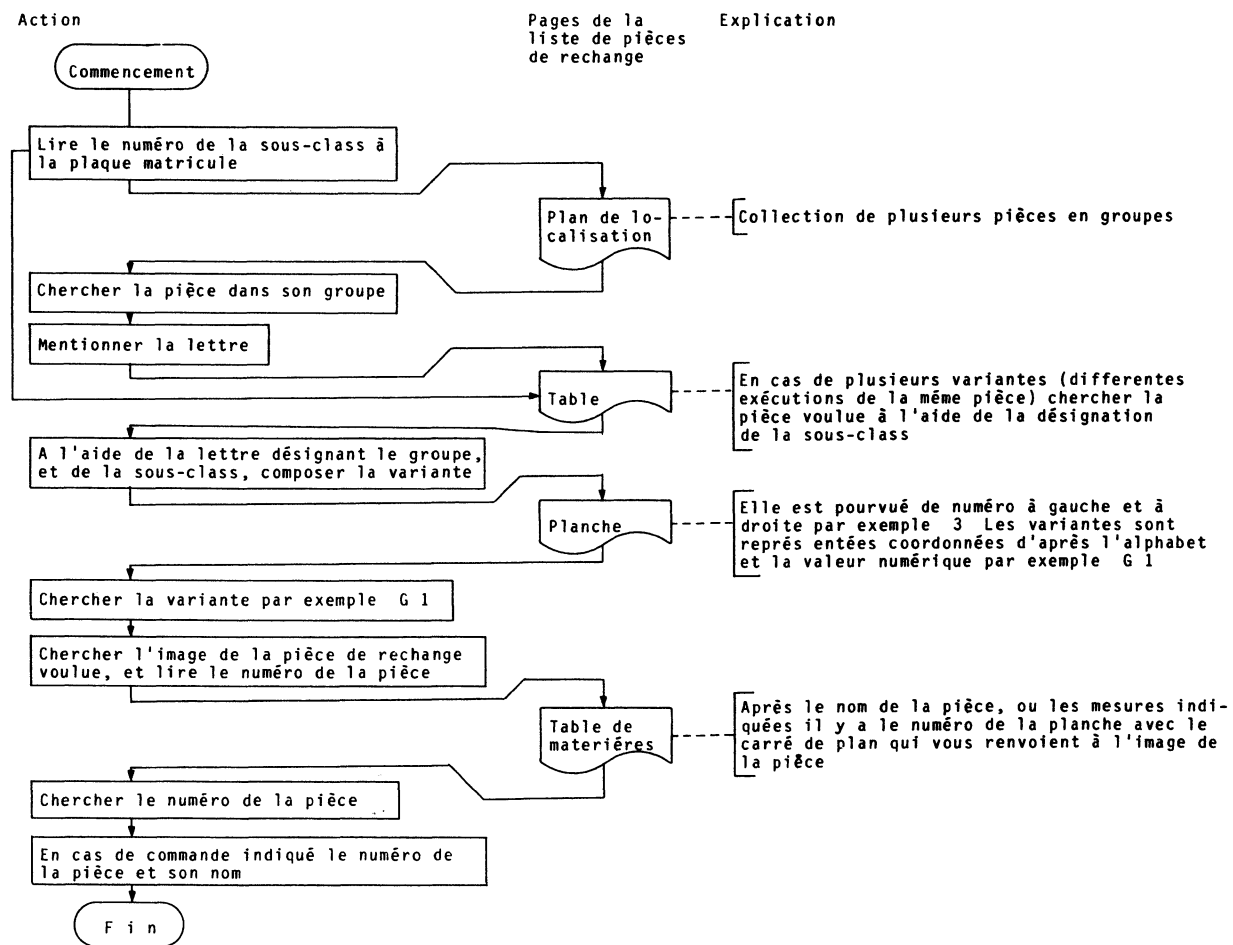

5. Toute reproduction, meme en partie, n'est autorisée qu'avec notre permis. Nous nous reservons le droit de change

Aclaraciones a la lista de piezas de repuesto

1. Generalidades

Listas de piezas de repuesto por separado las hay para juegos de costura y equipos extra en función con el cabezal de coser.

2. Marcado de las piezas de requesto

Las piezas sueltas pertenecientes a una unidad están encuadradas por una raya de puntos. La unidad también se puede pedir completa con el número encuadrado por completo (en un cajetín). A esta unidad no pertenece ninguna pieza cuyo número quede fuera de la raya punteada.

Las piezas señaladas con una "N" no se sirven solas.

Si no encuentra usted una pieza en la lista de piezas de requesto - cosa que puede ocurrir por haber variaciones técnicas -, indiquenos entonces, junto a la descripción de la pieza y su función, la subclase exacta y el número de fábrica que figura en la placa del tipo.

En los pedidos de piezas eléctricas rogamos que también se nos indiquen los datos adicionales que figuran entre paréntesis detrás del número de la pieza.

En el sumario figuran los números de las piezas en progresión ascendente. Además se indican:

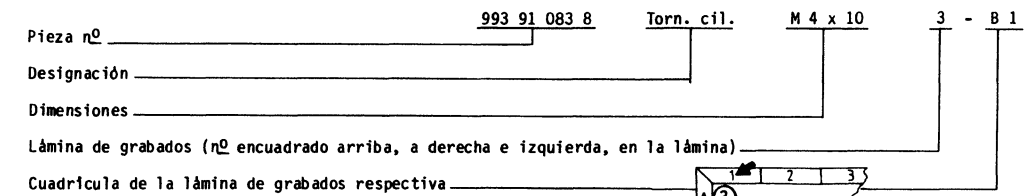

3. Símbolos empleados

- = Véase Instrucciones para el mecánico
- = Asegurar con liquido, pegar, obturar Loctite 270, nº 990 49 034 6
- = Asegurar con liquido, pegar, obturar Loctite IS-460, nº 990 49 037 1
- = Indicar largo y superficie
- = Sin cortahilos
- = Con cortahilos
- = izquierda
- = derecha
- = Advertencia de que hay diferencia de característica
- = 1 aguja
- = 2 agujas
- = medidas
- = ejecución antigua
- = a petición

4. Forma de proceder con la lista de piezas de repuesto

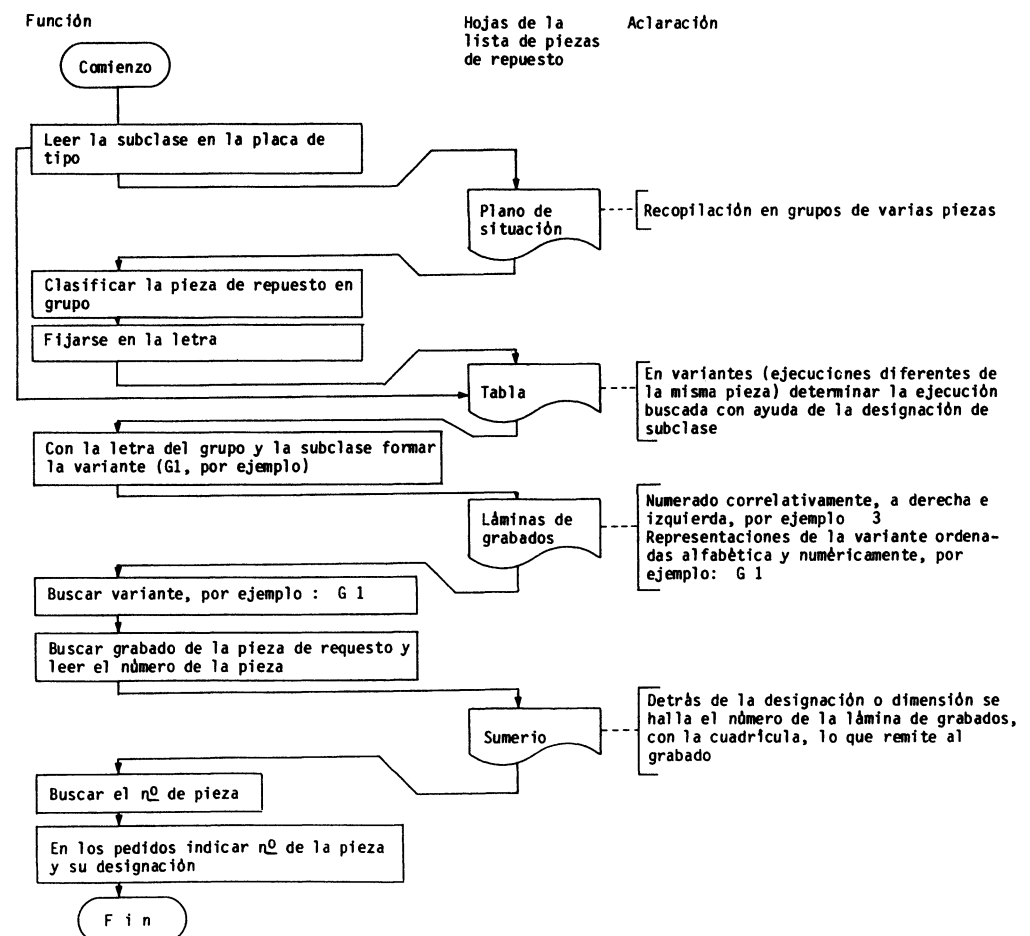

5. Toda reproducción, incluso extractada, sólo está permitida con nuestra autorización. Nos reservamos el derecho a hacer modificaciones.

1. Generalità

Esistono libretti parti di ricambio separati per: "Organi di cucitura", equipaggiamenti supplementari dipendenti dalla testa della macchina per cucire

2. Contrassegni dei pezzi di ricambio

Pezzi singoli componenti un gruppo sono racchiusi in una linea a punti e tratti. Il gruppo può essere anche ordinato completo indicando all'ordine il numero di pezzo incorniciato da una linea continua. I pezzi il cui numero è situato fuori della linea a punti e tratti non appartengono al gruppo

Pezzi contrassegnati con la lettera M non possono essere forniti come pezzo singolo

Nel caso che un pezzo non si trovi nel libretto parti di ricambio, ciò può succedere a causa delle continue innovazioni tecniche, indicate, accanto alla descrizione della funzione del pezzo e l'eventuale schizzo o descrizione minuta del pezzo, la classe e sottoclasse esatta ed il numero di fabbricazione riportati in targhetta

Ordinando componenti elettrici indicare i dati suppletivi segnati in parentesi dietro il numero del pezzo

Nell'indice i numeri dei pezzi sono ordinati secondo numero progressivo ed inoltre sono indicati:

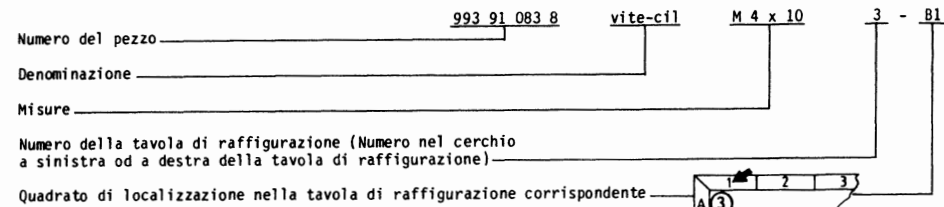

3. Simboli figurati utilizzati

- = Vedi libretto istruzioni per i meccanici
- = Senza rasafilo
- = Indicazione per notare le differenze tra i pezzi
- = 1 ago
- = Fissaggio, incollaggio o tenuta del pezzo tramite liquido Loctite 270, Nr. 990 48 034 6
- = Con rasafilo
- mm = Misura
- = 2 aghi
- = Fissaggio, incollaggio o tenuta del pezzo tramite liquido Loctite IS-460, Nr. 990 49 037 1
- = Sinistra (o)
- V = Esecuzione invecchiata
- = Destra (o)
- α.W. = A richiesta
- = Indicare la lunghezza o la superficie

4. Uso del libretto parti di ricambio

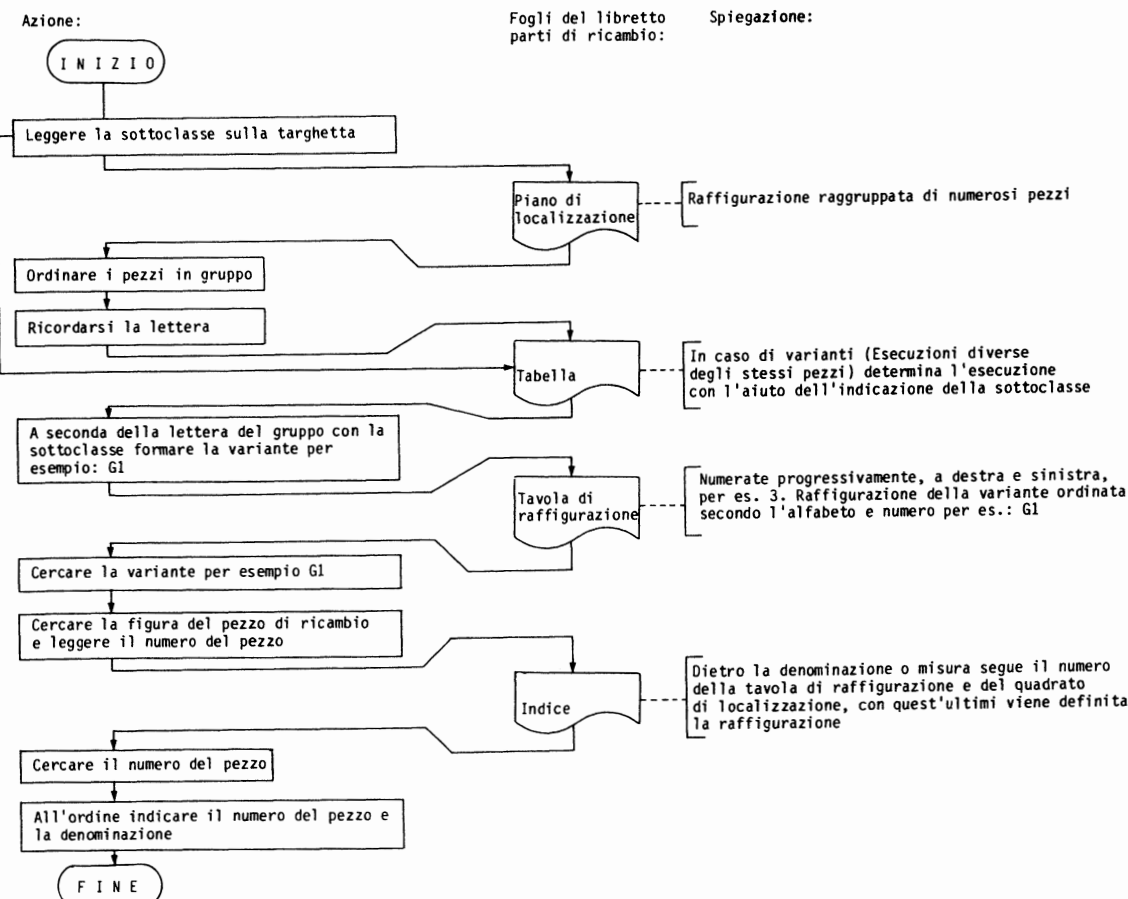

5. Ogni riproduzione intera o parziale è permessa solo con la nostra approvazione. Ci riserviamo ogni diritto di modifica. Gr.D.1

Unterklassen-Tabelle

Zeile	Unterklasse: 467-65	Gruppenaufstellung der Unterklassen. Zum Beispiel: A.1																Bemerkung:	
		A	B	C	D	E	F	G	H	I	J	K	L	M	N	O	P		Q
01																			
02	- 73	1	1	1	1	2	1	1	1	1	2	2	1	1	2	5	1	1	
03																			
04	FA - 73	1	1	1	1	2	1	1	1	1	2	2	1	1	4	7	2+3	1	
05																			
06																			
07																			
08																			
09																			
10																			
11																			
12																			
13																			
14																			
15																			
16																			
17																			
18	- 373	1	1	1	1	2	1	1	1	1	2	1	2	2	5	1	1		
19																			
20	FA - 373	1	1	1	1	2	1	1	1	1	2	1	2	4	7	2+3	1		
21																			
22																			
23																			
24																			
25	- 273	1	2	1	1	2	1	1	1	1	2	1	2	1+2	5	1	1		
26																			
27																			
28	FA - 273	1	2	1	1	2	1	1	1	1	2	1	2	3+4	7	2+3	1		K3 NA über 60 mm
29																			
30																			
31																			
32																			
33																			
34																			
35																			
36																			
37																			
38																			
39																			
40																			
41																			
42																			
43																			
44																			
45																			
46																			
47																			
48																			
49																			
50																			
51																			
52																			
53																			
54																			
55																			
56																			
57																			
58																			
59																			
60																			
61																			
62																			
63																			
64																			
65																			
66																			
67																			
68																			
69																			
70																			
71																			
72																			
73																			
74																			
75																			
76																			
77																			
78																			
79																			
80																			
81																			
82																			
83																			
84																			
85																			
86																			
87																			
88																			
89																			
90																			
91																			
92																			
93																			
94																			
95																			
96																			
97																			
98																			
99																			
100																			
101																			
102																			
103																			
104																			
105																			
106																			
107																			
108																			
109																			
110																			

= Ausrufklasse. Class to be discontinued

Lageplan 467-65... Situation plan

A - C =	①
D F =	②
G - H - J - K =	③
L - M =	④
N =	⑤
O ohne FA =	⑥
O mit FA =	⑦
P =	⑧
Q - R =	⑨

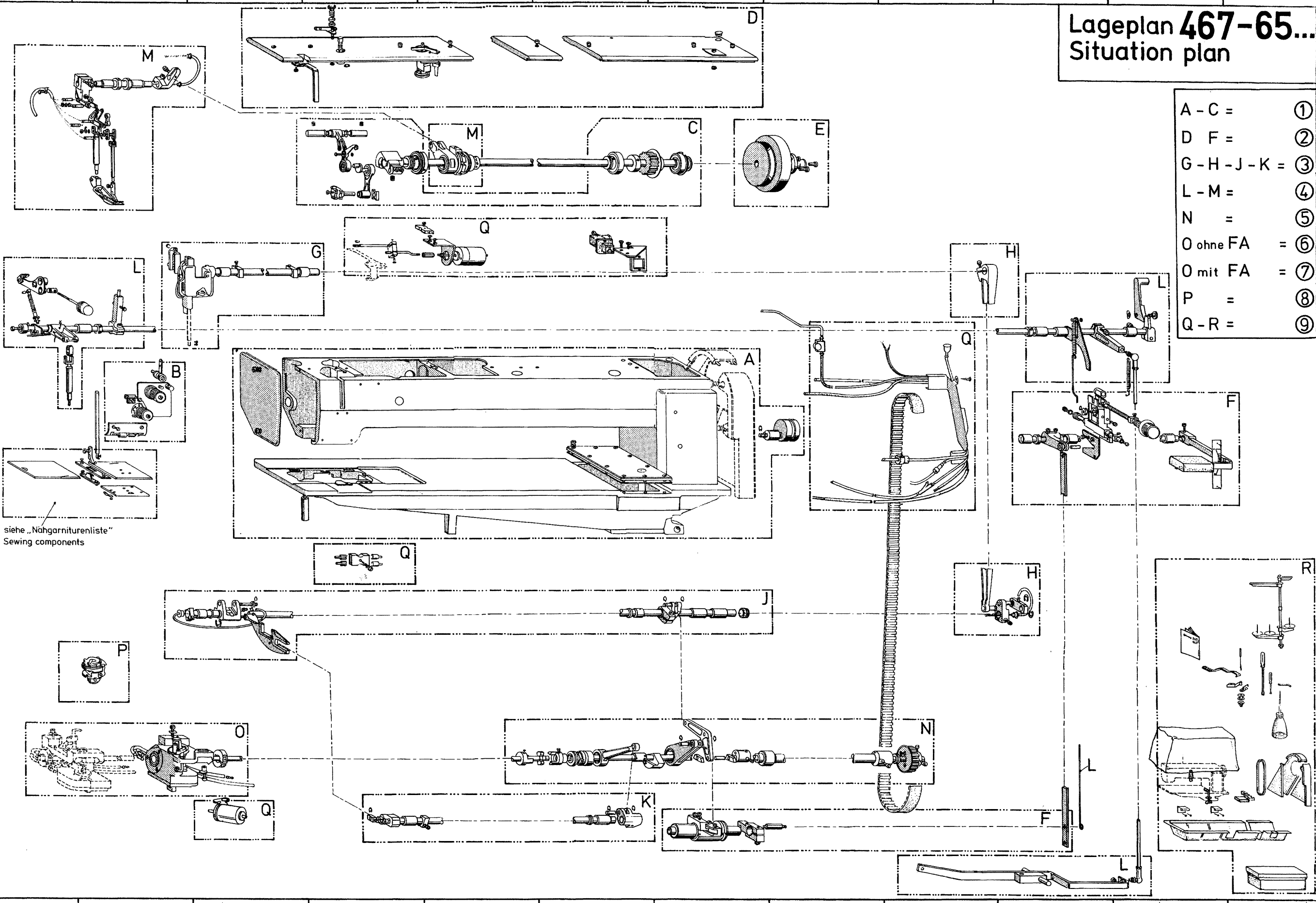

siehe „Nähgarniturenliste“
Sewing components

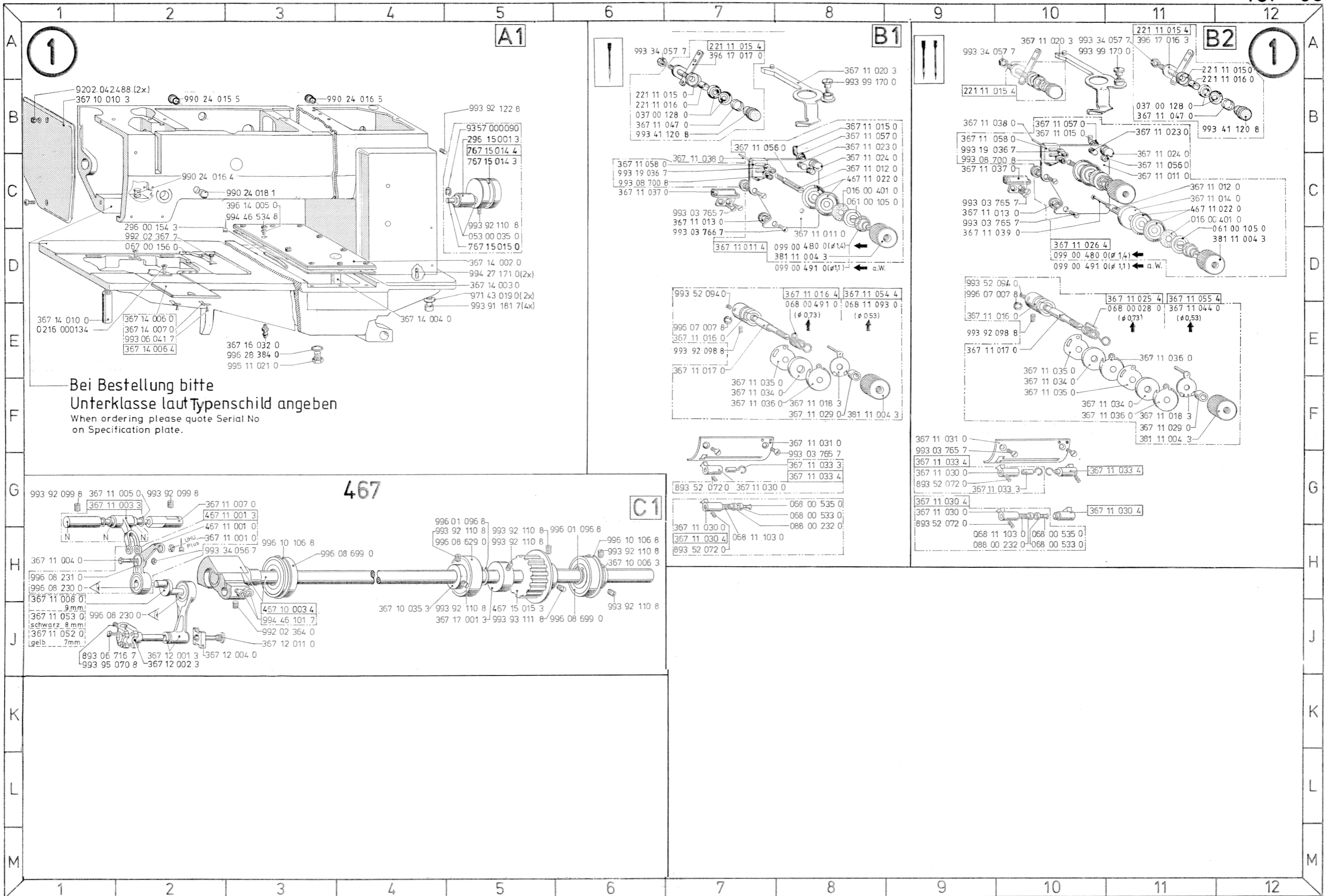

Bei Bestellung bitte
 Unterklasse laut Typenschild angeben
 When ordering please quote Serial No
 on Specification plate.

467

C1

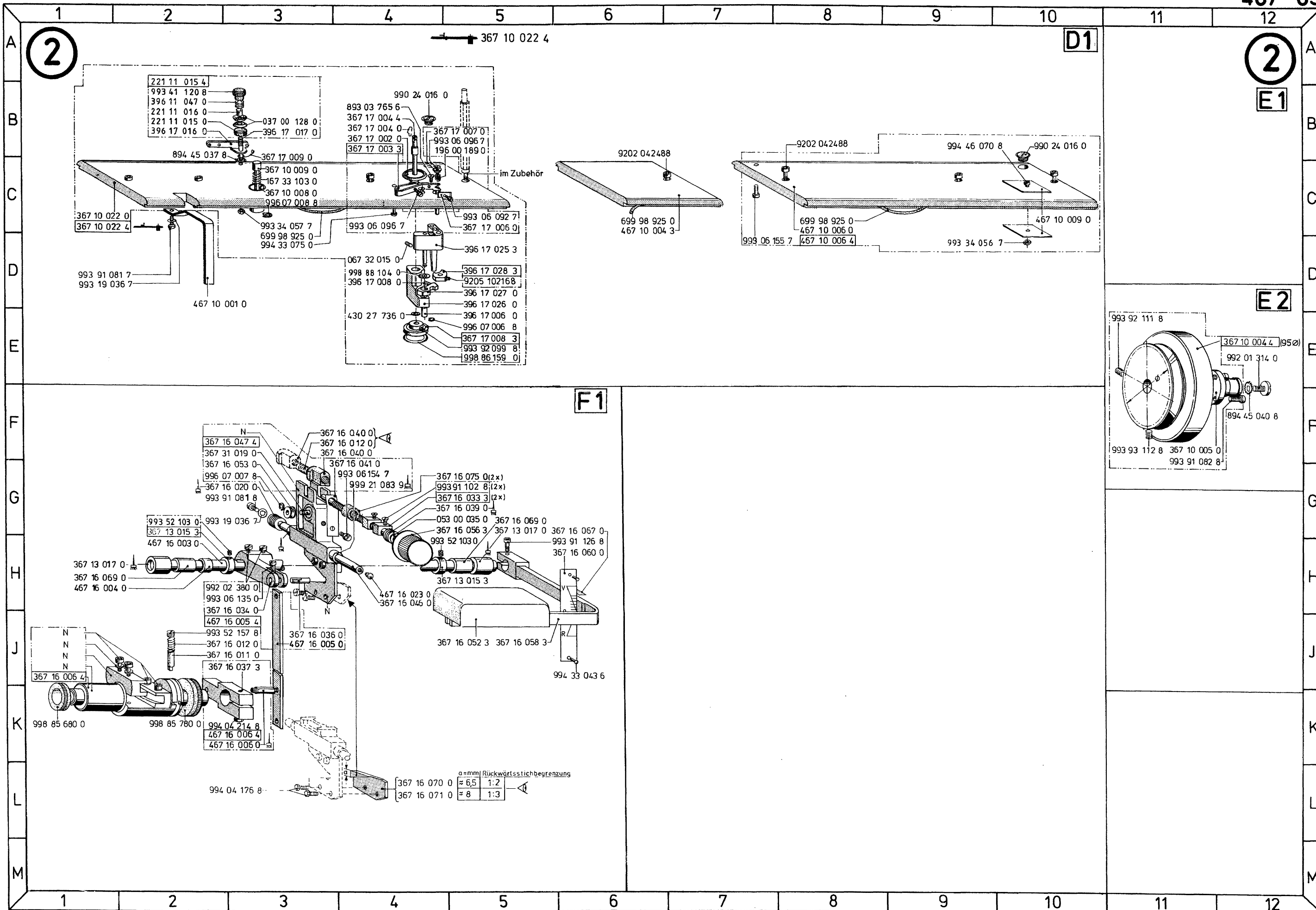

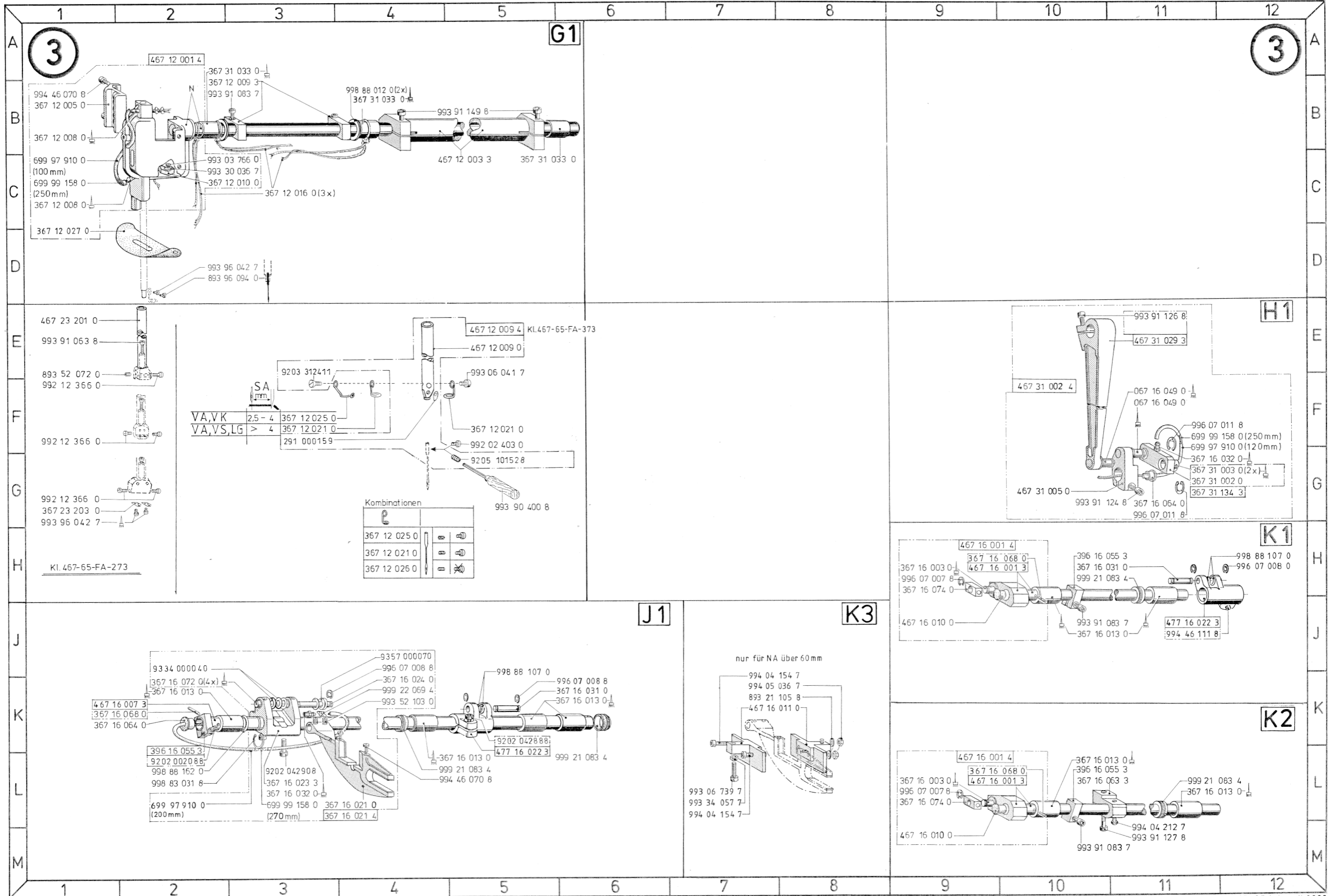

3

G1

3

H1

K1

J1

K3

K2

VA, VK	2,5 - 4	367 12 025 0
VA, VS, LG	> 4	367 12 021 0
		291 000159

Kombinationen

367 12 025 0	⊗	⊗	⊗
367 12 021 0	⊗	⊗	⊗
367 12 026 0	⊗	⊗	⊗

nur für NA über 60mm

993 06 739 7
993 34 057 7
994 04 154 7

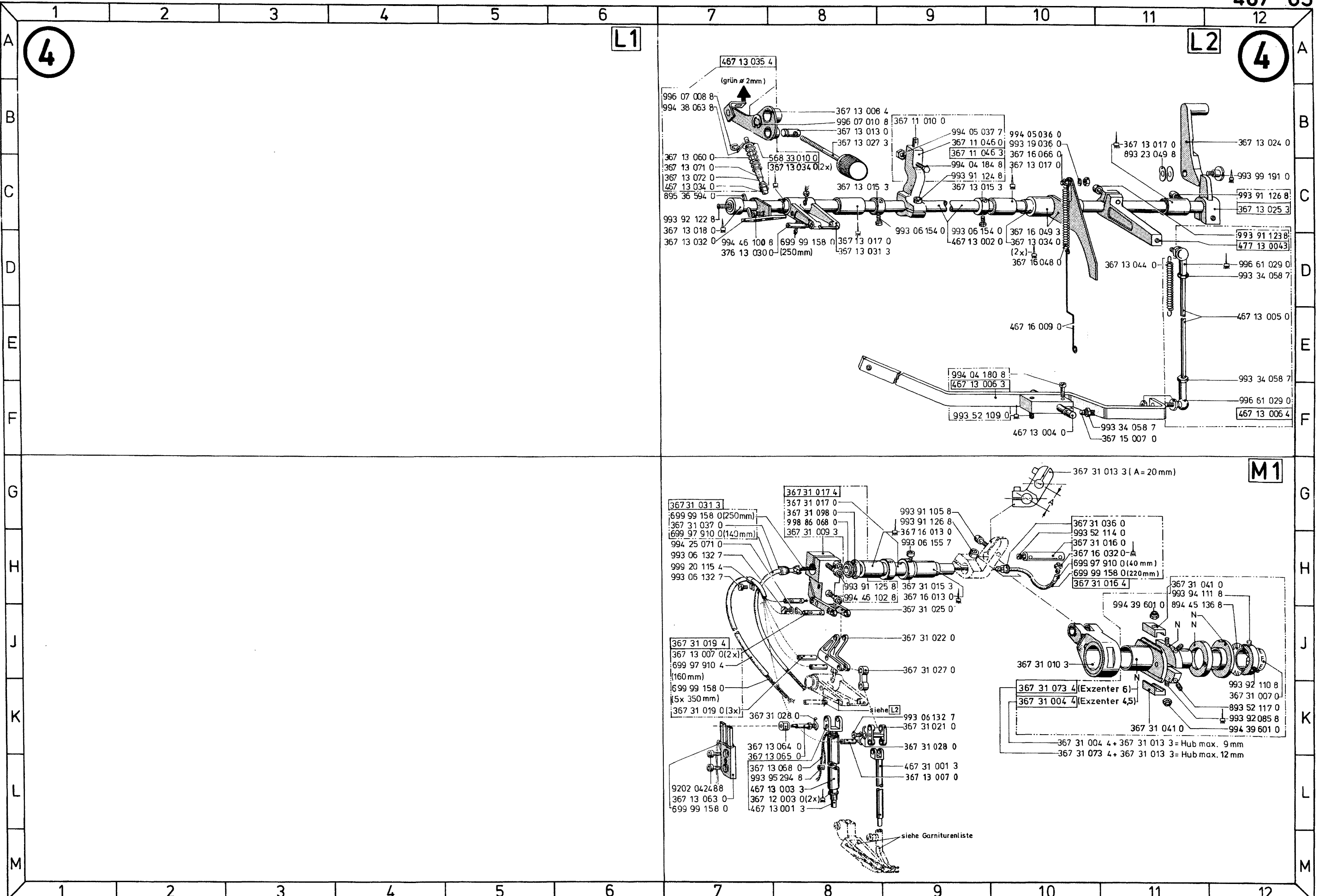

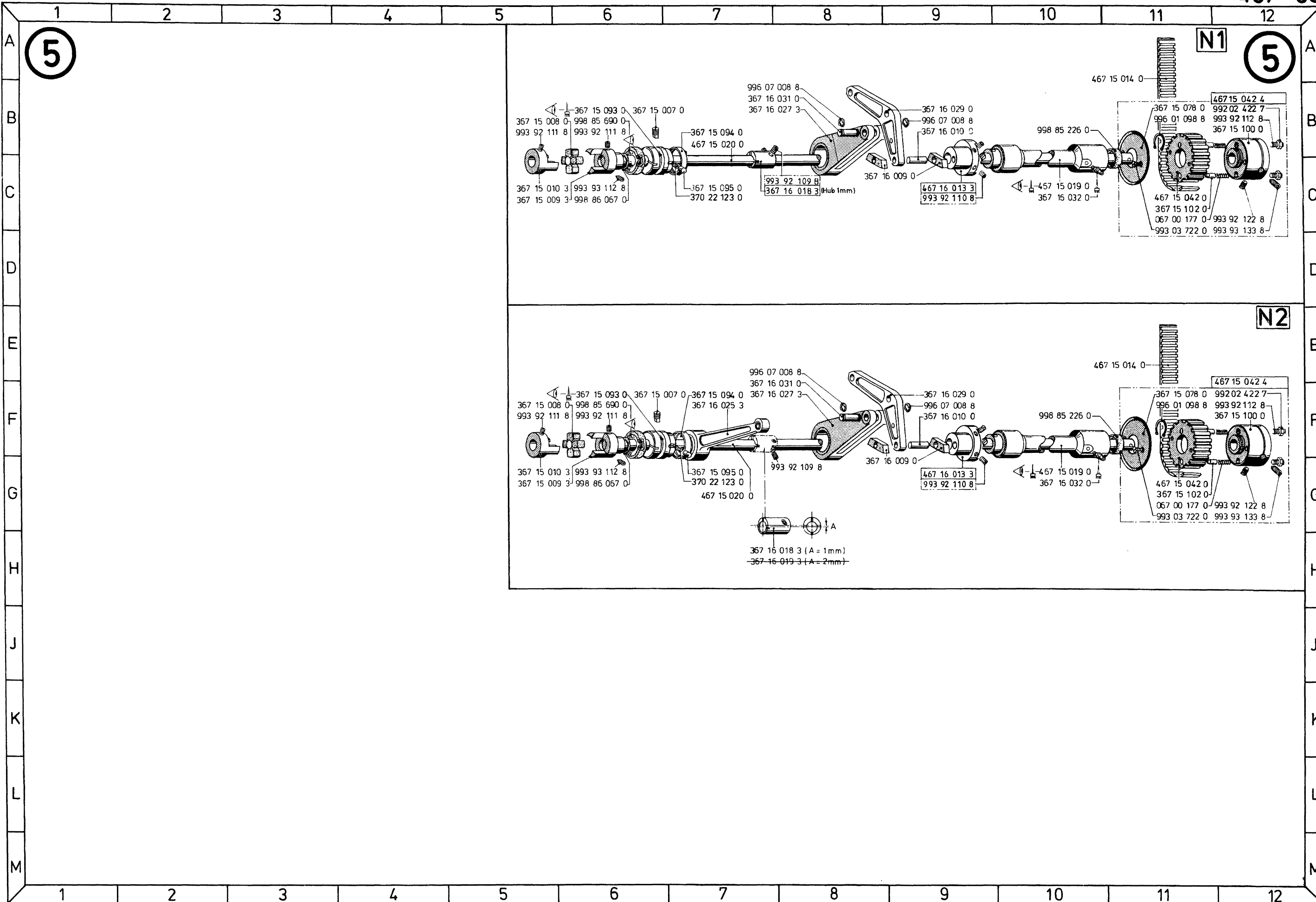

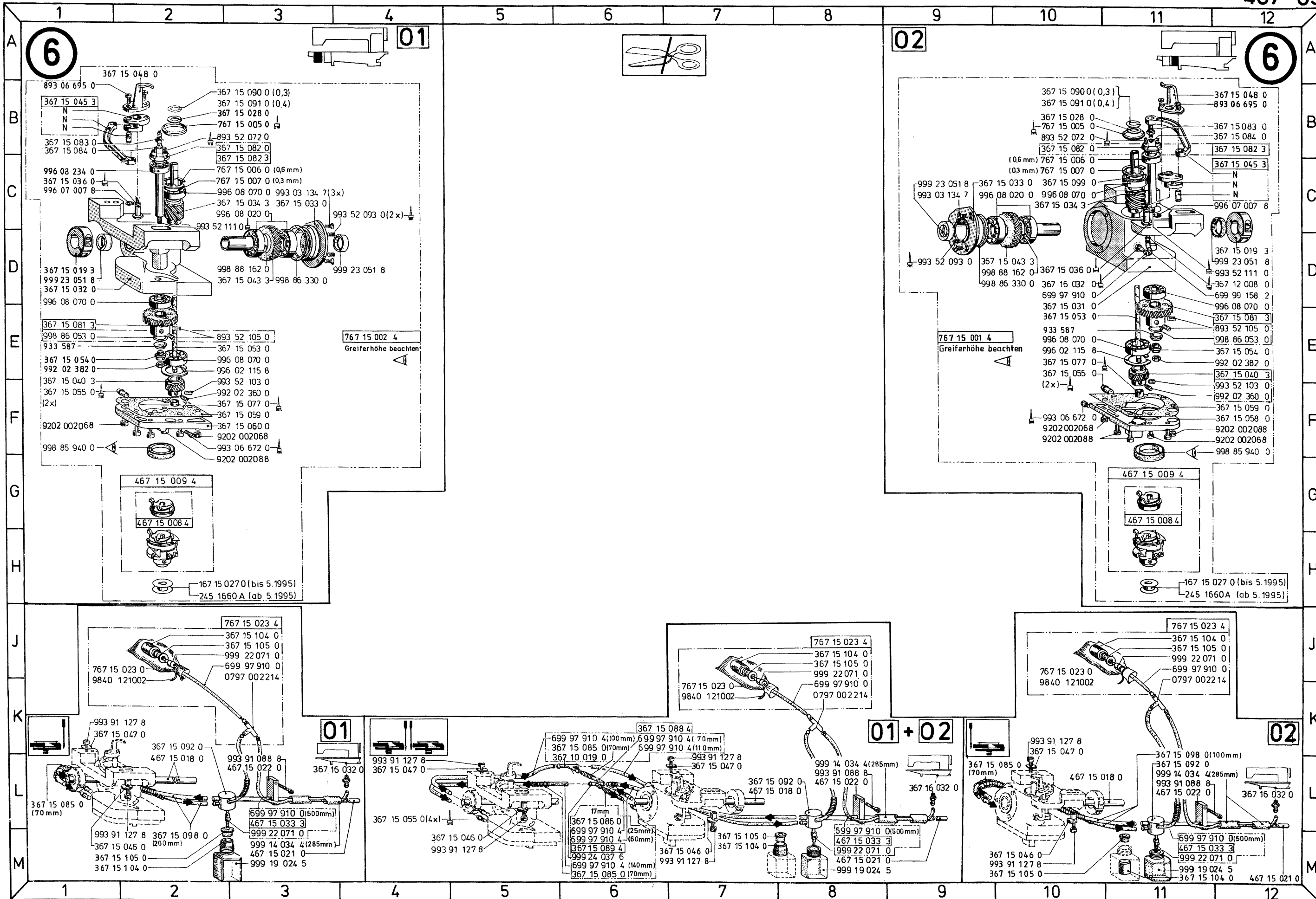

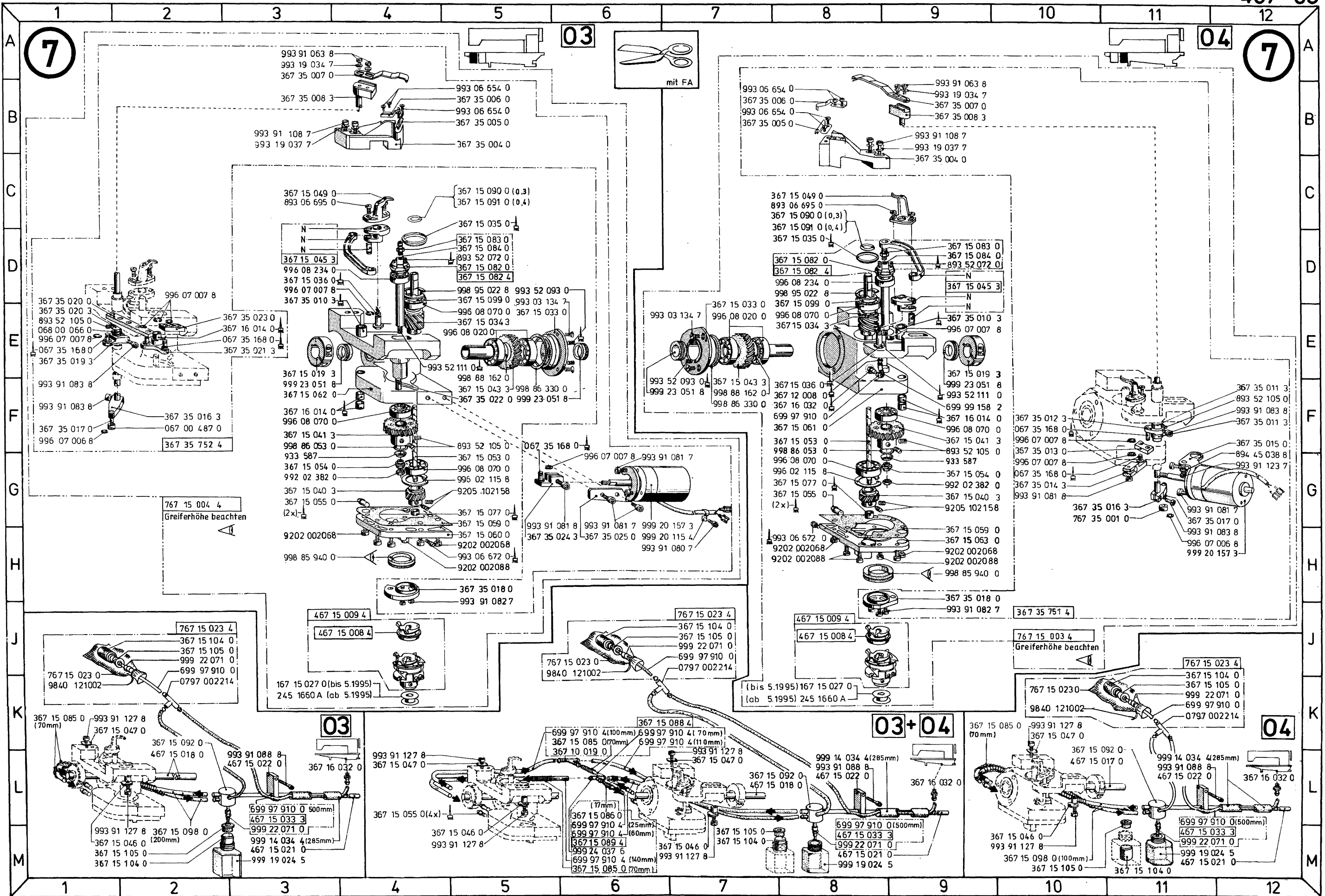

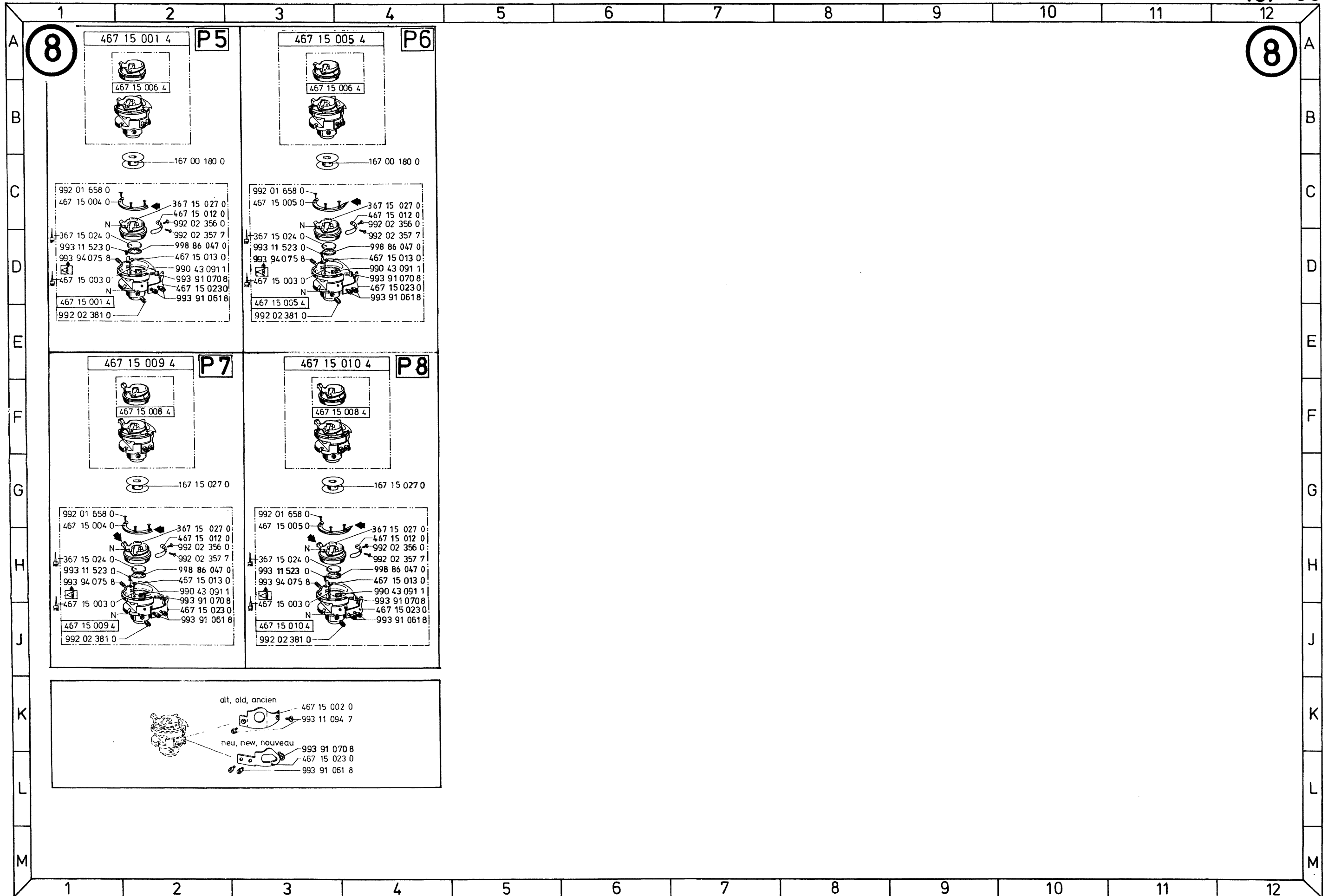

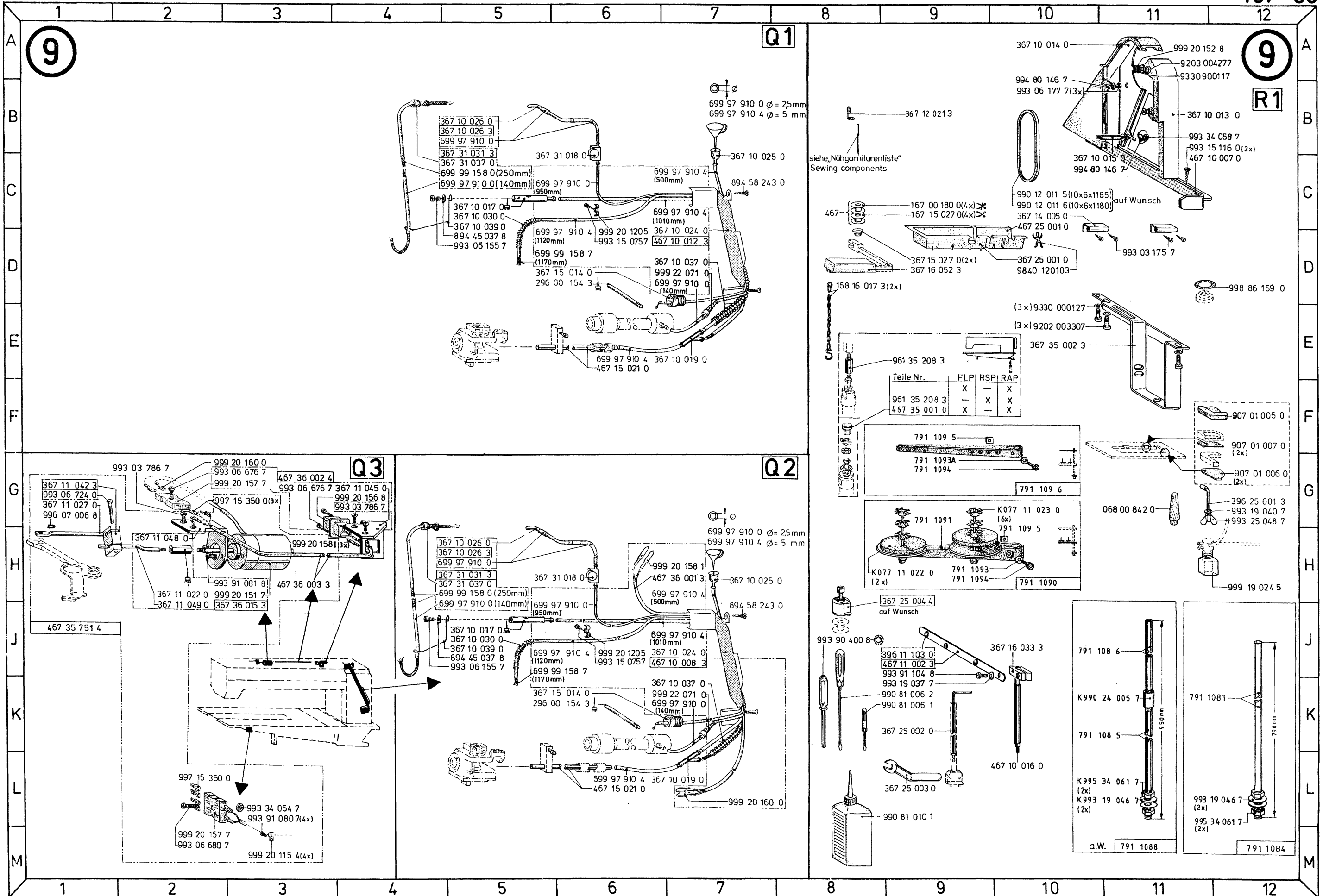

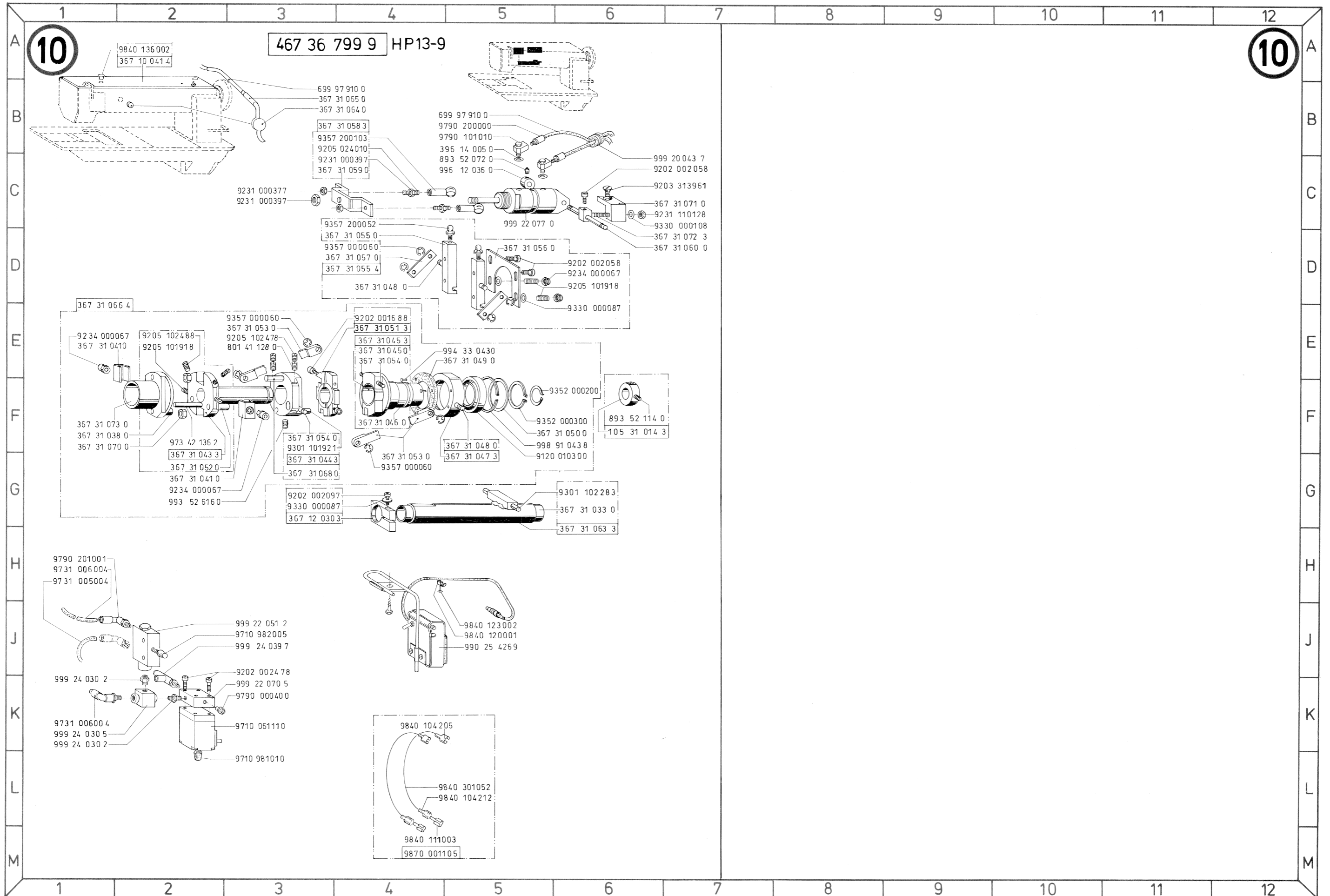

Teile-Nr.	Benennung	Bildtafel	Teile-Nr.	Benennung	Bildtafel	Teile-Nr.	Benennung	Bildtafel	Teile-Nr.	Benennung	Bildtafel
KLASSE 467-65		26.11.87	367 10 026 3	OELROHR	9H5 9B5	367 11 058 0	FADENFUEHRUNG	1C7 1B9	367 15 022 0	RING	7L3
016 00 401 0	SCHEIBE	1C8 1C11	367 10 030 0	DRUCKFEDER	9J5 9C5	367 12 001 3	NADELSTG.GELENK	1J2	367 15 024 0	DECKEL	8D1 8D3 861 863
037 00 128 0	FADENSPANN.SCHEIBE	1B6 1B11 2B3	367 10 035 3	LAGERHUELSE	1J4	367 12 002 3	NADELST.KLOBEN	1J2	367 15 027 0	KEGELSTUMPFEDER	8C2 8C4 864 9D9
053 00 035 0	SCHEIBE	1D5 265	367 10 037 0	STUETZFEDER	9K7 9D7	367 12 003 0	BUCHSE	4L7	367 15 028 0	DISTANZRING	6B3 6B10
061 00 105 0	ROSETTE	1C8 1C12	367 10 039 0	FEDERBUEGEL	9C5 9J5	367 12 004 0	GLEITSTEIN	1J3	367 15 031 0	GREIFERLAGER,RE	6D10
067 00 156 0	SPERRFEDER	1D2	367 11 001 0	OESE	1H3	367 12 005 0	GLEITFUEHRUNG	3B1	367 15 031 4	GREIFERLAGER,RE	6E10
067 00 177 0	DRUCKFEDER	5C11 5611	367 11 003 3	FADENHEBELLENKER	162	367 12 008 0	NIPPEL	3B1 3C1 6D12	367 15 032 0	GREIFERLAGER LI.	6D1 7L3
067 00 487 0	ROLLE	7F2 7610	367 11 004 0	LENKERBOLZEN	1H1	367 12 009 3	KLEMMKLOBEN	3B3	367 15 032 4	GREIFERLAGER LI.	6D1
067 16 049 0	BOLZEN	3F11	367 11 005 0	DICHTSCHEIBE	162	367 12 010 0	OELKISSEN	3C3	367 15 033 0	LAGERDECKEL	6C3 6C10 7E5
067 32 015 0	DRUCKFEDER	2D4	367 11 007 0	BUCHSE	163	367 12 011 0	GEWINDEBOLZEN	1J3			
067 35 168 0	BOLZEN	7E1 7E3 7F5	367 11 008 0	FADENHEBELKURBEL	1J2	367 12 016 0	OELDOCHT	3B3	367 15 034 3	GREIFERWELLE	6C3 6C10 7E5
		7F10 7610	367 11 010 0	ZAPPEN	4B9	367 12 025 0	FADENOESE	3F3 3F5 3H4			7E8
068 00 028 0	FADENANZ.FEDER	1E11	367 11 011 0	SPANNUNGSPLATTE	1D8 1C11	367 12 026 0	FADENOESE	3F3 3F5 3H4	367 15 035 0	OELFANGRING	6B3 6B10 ;7C5
068 00 066 0	DRUCKFEDER	7E1	367 11 011 4	FADENSP.TRAEGER	1D7	367 12 027 0	PLATTE	3D1			7D8
068 00 491 0	FADENANZ.FEDER	1E8	367 11 012 0	FADENSP.BOLZEN	1C8 1C9 1C10	367 12 076 0	NIPPEL	1E3	367 15 036 0	BOLZEN	6C1 6D10 7D3
068 00 493 0	FADENANZ.FEDER	1E6			1C11	367 13 007 0	BOLZEN	4J7 4L9			7F8
068 00 533 0	SCHEIBE	168 1H10	367 11 013 0	HUELSE	1C7 1C9	367 13 008 4	FEDERHEBEL	4B8	367 15 037 0	SCHWENKHEBEL	7D9
068 00 535 0	FADENF.BOLZEN	168 1H10	367 11 014 0	SCHEIBE	1C11	367 13 013 0	BOLZEN	4B8	367 15 038 0	BOLZEN	7E4
068 11 093 0	FADENANZUGSFEDER	1E8	367 11 015 0	ZUGHAKEN	1B10 1B8	367 13 015 3	STELLRING	2H5 2G2 4C9 4C8	367 15 040 3	STIRNRAD,KLEIN	6E1 6E12 763
068 11 103 0	DRUCKFEDER	1H7 1H10	367 11 016 0	VERSTELLBUCHSE	1E7 1E9	367 13 017 0	BUCHSE LANG	2G5 2H1 4D8 4C10			769
077 11 022 0	AUFLAGE	9K11	367 11 016 4	FADENFUEHRUNG	1D8				367 15 041 3	STIRNRAD	7F3 7F9
077 11 023 0	ZENTRIERSTUECK	9K10	367 11 017 0	BOLZEN	1E7 1E9				367 15 043 3	ANTRIEBSWELLE	6D3 6D10 7F5
077 11 025 0	ABSCHL.STUECK	9H12	367 11 018 3	DECKSCHEIBE	1E8 1E11						7F7
088 00 232 0	HUELSE	1H8 1H10	367 11 020 3	AUSLOESEHEBEL	1A10 1A8	367 13 018 0	BUCHSE KURZ	4C7	367 15 045 0	ZUGSTANGE	7D9
099 00 480 0	FADENSP.FEDER	1D8 1D10	367 11 022 0	EINSTELLMUTTER	9H2	367 13 019 0	FUEHRUNGSSTANGE	4B8	367 15 045 3	ZUGSTANGE	6B1 6C12 7D3
099 00 491 0	KEGELFEDER	1D8 1D10	367 11 023 0	UMLENKSTIFT	1B8	367 13 020 0	FEDERFUEHRUNG	4C7	367 15 046 0	EXZENTERBUCHSE	6M1 6M4 6M7 6M10
167 00 180 0	SPULE	8C2 8C4 9C9	367 11 024 0	DRUCKKNOPF	1B8 1C11	367 13 024 0	LUEFTERHEBEL	4B12			7M1 7M5 7M7
167 15 027 0	SPULE	8F2 8F4 9C9	367 11 025 4	FADENFUEHRUNG	1D11	367 13 025 3	LUEFTERKLOBEN	4C12			7M10
167 33 103 0	DRUCKFEDER	1C3	367 11 026 4	FADENSP.TRAEGER	1D10	367 13 027 3	SPINDEL	4B8			
168 16 017 3	KETTE	9D8	367 11 027 0	ZUGSTANGE	9G1	367 13 030 0	BOLZEN	4D7	367 15 047 0	SCHEIBE	6K1 6L4 6L7 6K10
196 00 189 0	DRUCKFEDER	2B5	367 11 029 0	BUCHSE	1F8 1F11	367 13 031 3	GABELHEBEL	4D8			7K2 7L4 7L7
221 11 015 0	SCHEIBE	1B6 1A12 2B2	367 11 030 0	FADENF.KOERPER	1H7 169	367 13 032 0	GABELHEBEL	4D7			7K10
221 11 015 4	VORSPANNUNG	1A7 1B9 1A11	367 11 030 4	FADENFUEHRUNG	1H7 169 1611	367 13 034 0	BUCHSE	4C8 4D10	367 15 048 0	SPULENGEH.LUEFTER	6A2 6B12
		2B2	367 11 031 0	FADENF.BLECH	1F8 1F9	367 13 044 0	ZUGFEDER	4D11	367 15 049 0	SPULENGEH.LUEFTER	7C3 7D9
221 11 016 0	BUCHSE	1B6 1B12 2B2	367 11 033 3	HAKEN	168 1610	367 13 060 4	DRUCKFEDER	4A7	367 15 053 0	SPINDEL	6E3 6E10 765
296 00 051 0	SCHEIBE	3J3 3J2	367 11 033 4	FADENFUEHRUNG	168 169 1611	367 13 063 0	FUEHRUNG	4L7			7F8
296 00 154 3	LUEFTUNGSROHR	1C2 9D6 9K6	367 11 034 0	FADENANZUGSROLLE	1F7 1E9 1F10	367 13 064 0	GLEITSTEIN	4K7	367 15 054 0	MUTTER	6E1 6E12 763
296 00 209 0	SPANNROLLENACHSE	1D5			1F11	367 13 065 0	BOLZEN	4J7			769
296 00 210 0	SPANNROLLE	1D5	367 11 035 0	ZWISCHENSCHLEIBE	1F7 1E8 1E10	367 13 068 0	OELDOCHT	4L7	367 15 055 0	NIPPEL	6F1 6L4 6E10
296 25 002 0	OBERTEILSTUETZE	9H11			1F10	367 14 002 0	DECKEL	1D5			763 768 7M4
367 10 004 4	HANDRAD	2E12	367 11 036 0	FUEHRUNGSSCHLEIBE	1F7 1D9 1F11	367 14 003 0	DECKELDICHTUNG	1D5	367 15 058 0	DECKEL,RE.	6F12
367 10 005 0	FLANSCH	2F11	367 11 037 0	FADENF.OESE	1C6 1C6	367 14 004 0	OELSTANDSANZEIGER	1E4	367 15 059 0	DICHTUNG	6F3 6F12 765
367 10 006 3	LAGERHUELSE	1H6	367 11 038 0	STIFT	1C7 1B9	367 14 005 0	SCHARNIER	9C10			7H9
367 10 008 0	BUCHSE	2C3	367 11 039 0	STIFT	1D9	367 14 006 0	APPARATESCHIEBER	1E2	367 15 060 0	DECKEL,LI.	6F3 7H5
367 10 009 0	BOLZEN	2C3	367 11 042 3	KLOBEN	9G1	367 14 006 4	APPARATESCHIEBER	1E2	367 15 061 0	GREIFERLAGER,RE LI	7F8
367 10 010 3	KOPFDECKEL	1B1	367 11 044 0	FADENANZ.FEDER	1E11	367 14 007 0	BLATTFEDER	1E2 5B6	367 15 061 4	GREIFERLAGER,RE	769
367 10 013 0	RIEMENSCHUTZ,VORN	9B11	367 11 045 0	STECKERTRAEGER	9G4	367 14 010 0	FUSS	1E1	367 15 062 0	GREIFERLAGER,LI	7F3
367 10 014 0	RIEMENSCHUTZ,HINT.	9A10	367 11 046 0	HEBEL	4B9	367 15 007 0	GEWINDESTIFT	4F11 5F6	367 15 062 4	GREIFERLAGER,LI	763
367 10 015 0	BOLZEN	9C10	367 11 046 3	HEBEL	4B9	367 15 008 0	ZAHNKRANZ	5B5 5F5	367 15 063 0	DECKEL,RE	7H9
367 10 017 0	OELNIPPEL	9J5 9C5	367 11 048 0	MAGNETTRAEGER	9H2	367 15 009 3	KUPPL.KLAUE RE.	5C5 5G5	367 15 077 0	BUCHSE	6F3 6E10
367 10 019 0	ABZWEIGROHR	6L6 7L6 9E7 9L7	367 11 049 0	STANGE	9J2	367 15 010 3	KUPPL.KLAUE LI.	5C5 5G5	367 15 078 0	SCHEIBE	5B11 5F11
367 10 022 0	ARMDECKEL	2C1	367 11 052 0	FADENHEBELKURVE	1J1	367 15 011 0	SPANNROLLE LAGER	1C5	367 15 080 0	KOERPER	6B12
367 10 022 4	ARMDECKEL	2C1 2A5	367 11 053 0	FADENHEBELKURVE	1J1	367 15 011 4	SPANNROLLE	1B5	367 15 081 3	STIRNRAD	6E1 6E12
367 10 024 0	SCHUTZBLECH	9J9 9C7	367 11 054 4	VERSTELLBUCHSE	1D8				367 15 082 0	EXZENTERWELLE	6B3 6B10
367 10 025 0	EINFUELLTRICHTER	9H7 9C7	367 11 055 4	VERSTELLBUCHSE	1D11	367 15 014 0	STOPFEN	9K6 9D6			7D5 7D8
367 10 026 0	OELSCHLAUCH	9H5 9B6	367 11 056 0	DREHFEDER	1B7 1C11	367 15 016 3	ZAHNRIEMENRAD	1J5	367 15 082 4	EXZENTERWELLE	6C3 6B12 7D5
			367 11 057 0	KEGELSTUMPFEDER	1B10 1B8	367 15 019 3	KLEMMRING	6D1 6D12 7E3			7D8
								7E9			

Teile-Nr.	Benennung	Bildtafel	Teile-Nr.	Benennung	Bildtafel	Teile-Nr.	Benennung	Bildtafel	Teile-Nr.	Benennung	Bildtafel
367 15 083 0	BOLZEN	6B1 6B12 7D5 7D9	367 16 033 3	KLEMMKLOBEN	9J10	367 31 019 4	DOCHTHALTER	4J7	396 16 055 3	STELLKLOBEN	3K2 3H10 3L10
367 15 084 0	PRISMA	6B1 6B12 7D5 7D9	367 16 034 0	HEBEL	2H3	367 31 021 0	GELENK	4K9	396 17 006 0	HUELSE	2E5
367 15 085 0	STUETZFEDER	6K1 6K6 6M6 6K9 7K1 7K6 7M6 7K9	367 16 036 0	BOLZEN	2J3	367 31 022 0	LENKER	4J9	396 17 008 0	DRUCKFEDER	2D4
367 15 086 0	STUETZFEDER	6L6 7L6	367 16 037 3	KLOBEN	2J3	367 31 025 0	ZUGSTANGE	4J9	396 17 015 4	SPULERVORSPANNUG	1A9 2B3
367 15 088 4	ABLAUFSCHLAEUCHE	6K6 7K7	367 16 039 0	BUCHSE	2G5	367 31 027 0	ZUGSTANGE	4J10	396 17 016 3	FADENFUEHRUNG	1A7 1A11 2B2
367 15 089 4	ZULAUFSCHLAEUCHE	6M6 7M6	367 16 040 0	AUSGLEICHSTUECK	2F4	367 31 028 0	SICHERUNGSBLECH	4K7 4K9	396 17 018 0	FADENSP.BUCHSE	1A6 1B9 2B3
367 15 090 0	PASS-SCHEIBE 0,3	6A3 6B10 7C5 7C8	367 16 041 0	BLATTFEDER	2G4	367 31 031 3	OELSCHLAUCH	4G7 9H5 9B5	396 17 024 3	SPULERRAD	2E5
367 15 091 0	PASS-SCHEIBE 0,4	6B3 6B10 7C5 7C8	367 16 046 0	GLEITSTANGE	2H4	367 31 033 0	BUCHSE	3A3 3B4 3C5	396 17 025 3	SPULERBOCK	2D5
367 15 092 0	FLASCHENHALTER	6K2 6L7 6L11 7K2 7L7 7L10	367 16 047 4	GLEITGABEL	2F3	367 31 036 0	DICHTSTOPFEN	4G10	396 17 026 0	SPULERARM	2D5
367 15 093 0	BUCHSE	5B6 5F6	367 16 048 0	ZUGFEDER	4D10	367 31 037 0	DICHTSTOPFEN	4H7 4H10 9H5 9C5	396 17 027 0	EINRUECKKLOBEN	2D5
367 15 094 0	LAUFRAD	5B7 5F7	367 16 049 3	FEDERBUEGEL	4D10	367 31 041 0	KLEMMSTUECK	4H11 4K10	396 17 028 3	AUSLOESENOCKEN	2D5
367 15 095 0	KOLBEN	5C7 5G7	367 16 052 3	POLSTER	2J5 9D9	367 31 073 4	EXZENTER KPL.	4K10	396 25 001 3	HAKENSCHR.	9G12
367 15 098 0	OELSCHLAUCH	6M2 6M10 6K11 7M2 7M10	367 16 053 0	ROLLE	2G3	367 31 098 0	KAPPE	3G3	430 27 736 0	SCHEIBE	2E4
367 15 099 0	DISTANZSCHEIBE	6C3 6C4 7D5 7E8	367 16 056 3	GEWINDESPINDEL	2G5	367 35 004 0	MESSERTRAEGER	7B5 7C9	467 10 001 0	FADENHEBELSCHUTZ	2D3
367 15 100 0	KOERPER	5B12 5F12	367 16 058 3	STICHST.GRIFF	2J5	367 35 005 0	MESSER	7B5 7B7 9E10	467 10 003 4	ARMWELLE	1J3
367 15 102 0	PISTON	5C11 5G12	367 16 060 0	STICHST.SKALA	2H6	367 35 006 0	KLEMMFEDER	7B5 7B7 9D10	467 10 004 3	ARMDECKEL,MITTE	2C6
367 15 104 0	FILTERTOPF	6M1 6M7 6M11 7M1 7M7 7M11	367 16 063 3	KLEMMKLOBEN	3L10	367 35 007 0	FADENZIEHMESSER	7A3 7B9 9D10	467 10 006 0	ARMDECKEL	2C8
367 15 105 0	HUELSE	6M1 6M7 6M10 7M1 7M7 7M10	367 16 064 0	DICHTSTOPFEN	3K2 3G11	367 35 008 3	FADENZ.TRAEGER	7B3 7B9	467 10 006 4	ARMDECKEL	2D8
367 16 003 0	BOLZEN	3H9 3L9	367 16 066 0	BOLZEN	4B10	367 35 010 3	BUCHSE	7D3 7E9	467 10 007 0	WINKEL	9C11
367 16 006 4	STELLWELLE	2J1	367 16 067 0	FOLIE	2G6	367 35 011 3	STELLRING	7F12	467 10 008 3	SCHLAUCHHALTER	9J7
367 16 009 0	GLEITSTEIN	5C8 5G8	367 16 068 0	STIFT	3K2 3L9 3H9	367 35 012 3	HEBEL	7F10	467 10 009 0	ABDECKBLECH	2C10
367 16 010 0	BOLZEN	5B9 5F9	367 16 069 0	BUCHSE	2G5 2H1	367 35 013 0	ZUGSTANGE	7G10	467 10 012 3	SCHLAUCHHALTER	9D7
367 16 011 0	KEIL	2J3	367 16 070 0	ANSCHLAGBLECH	2L4	367 35 014 3	KLOBEN	7G10	467 10 016 0	BOLZEN	9L10
367 16 012 0	DRUCKFEDER	2F4 2J3	367 16 071 0	ANSCHLAGBLECH	2L4	367 35 015 0	MAGNETTRAEGER	7F12	467 11 001 0	FADENHEBEL	1H3
367 16 013 0	BUCHSE	1H8 3K2 3K6 3L5 3J10 3L10 3L11 4H8 4H9	367 16 072 0	BUCHSE	3K2	367 35 016 3	HEBEL	7F2 7G10	467 11 001 3	FADENHEBEL	1G3
367 16 014 0	BUCHSE	3K6 3H12 7E3 7F3 7F9	367 16 074 0	GLEITSTEIN	3H9 3L9	367 35 017 0	BOLZEN	7F1 7G11	467 11 002 3	FADENFUEHRUNG	9J9
367 16 017 3	SCHIEBEXZENTER	5H9	367 16 075 0	DISTANZHUELSE	2G5	367 35 018 0	KURVENSCHLEIBE	7H5 7H9	467 11 022 0	SPANNUNGSSCHB.	1C8 1C11
367 16 018 3	HUBEXZENTER	5B7 5H7 5C8	367 17 001 3	MITNEHMERRAD	1J5	367 35 019 3	DICHTSTOPFEN	4H10	467 12 001 4	NADELSTG.SCHWINGE	3A2
367 16 019 3	HUBEXZENTER	5H7	367 17 002 0	BUNDBUCHSE	2B4	367 35 020 0	ZUGSTANGE	7E1	467 12 003 3	VERSTEIFUNG	3C5
367 16 020 0	BUCHSE	2G3	367 17 003 3	AUSLOESEHEBEL	2B4	367 35 020 3	STELLRING	7E1	467 13 001 3	STOFFDR.STANGE	4L8
367 16 021 0	TRANSP.BALKEN	3L4	367 17 004 0	KLEMMFEDER	2B4	367 35 021 3	WINKELHEBEL	7E3	467 13 002 0	WELLE	4D9
367 16 021 4	TRANSP.BALKEN	3L4	367 17 004 4	SPULERWELLE	2B4	367 35 022 0	BOLZEN	7F5	467 13 003 3	BUCHSE	4L7
367 16 023 3	KLOBEN	3L3	367 17 006 0	MESSER	2C6	367 35 023 0	ZUGSTANGE	7E3	467 13 004 0	WELLE	4F10
367 16 024 0	BOLZEN	3K4	367 17 007 0	SCHEIBE	2B5	367 35 023 4	KLOBEN	7H5	467 13 005 0	STANGE	4E12
367 16 025 3	ZUGSTANGE	5F7	367 17 008 3	SPULERRAD	2E5	367 35 024 3	FADENSP. MAGNET	9J3	467 13 006 3	HEBEL, LANG	4E9
367 16 027 3	ZUGSTANGE	5B7 5F7	367 17 009 0	FADENFUEHRUNG	2B3	367 35 025 0	MAGNETTRAEGER	7H6	467 13 006 4	HEBEL	4F12
367 16 029 0	HEBEL	5B9 5F9	367 23 203 0	FADENOESE	3G1	367 35 751 4	FADENABSCHNEIDER	7C9 7J10	467 13 008 3	HEBEL	9E9 9F9
367 16 031 0	BOLZEN	3K6 3H10 5B7 5F7	367 25 001 0	OELFANGMULDE	9D10	367 35 752 4	FADENABSCHNEIDER	7C3 7F2	467 15 001 4	GREIFER	8A2 8D1
367 16 032 0	NIPPEL	1E3 3L3 3G11 4H10 5C10 6L3 6L9 6L12 6D10 7F8 7L12 7L9	367 25 002 0	SCHRAUBENDREHER	9K9	367 35 757 4	GREIFER KPL.	7J10	467 15 002 0	NADELSCHUTZ	8J3
			367 25 003 0	MAULSCHLUESSEL	9L9	367 35 758 4	GREIFER KPL.	7G2	467 15 003 0	OELROHR	8D1 8D3 8H1 8H3
			367 25 004 0	WINKEL	9H9	367 35 759 4	GREIFER KPL.	6E4	467 15 004 0	DECKRING	8C1 8G1
			367 31 002 0	ZUGSTANGE	3G11	367 35 760 4	GREIFER KPL.	6E9	467 15 005 0	DECKRING	8C3 8G3
			367 31 002 3	ZUGSTANGE	3G11	367 36 015 3	FADENSP.MAGNET	9J3	467 15 005 4	GREIFER	8A3 8D3
			367 31 003 0	BUCHSE	3G11	370 22 123 0	DRUCKFEDER	5C7 5G7	467 15 006 4	SPULENGEHAUSE	8B2 8B3
			367 31 004 4	EXZENTER	4K10	381 11 004 3	RAENDELMUTTER	1D8 1F8 1F11 1C12	467 15 008 4	SPULENGEHAUSE	8E2 8E4
			367 31 005 3	KLOBEN	3G10				467 15 009 4	GREIFER	8E2 8H1
			367 31 007 0	SKALENSCHLEIBE	4K12	396 11 019 4	GARNSTAENDER	9M11	467 15 010 4	GREIFER	8E3 8H3
			367 31 009 3	HEBEL	4H8	396 11 026 0	SPANNUNGSBUCHSE	2B3	467 15 012 0	SPANNUNGSFEDER	8C2 8D2 8H2 8C4 8D4 8H4
			367 31 010 3	ZUGSTANGE	4J10	396 11 047 0	DRUCKFEDER	1B6 1B11 2B2	467 15 013 0	ABDECKBLECH	8D2 8H2 8D4 8H4
			367 31 013 3	KLOBEN	4G10 4K11	396 11 101 0	TRAEGER	9L12	467 15 014 0	ZAHNFORMRIEMEN	5A11 5E11
			367 31 015 3	STELLRING	4H9	396 11 102 3	FADENLEITARM	9J11	467 15 015 3	ZAHNRIEMENRAD	1J5
			367 31 016 0	BOLZEN	4H10	396 11 103 0	FADENOESE	9J9 9J11	467 15 017 0	WELLE	7L11
			367 31 016 4	BOLZEN	4H10	396 11 104 0	GARNROLLENTELLER	9K10	467 15 018 0	WELLE, VORNE	6L2 6L7 6L10 7L2 7L7 7L10
			367 31 017 0	WELLE	1G8 4G8	396 11 105 0	GARNR.-STIFT	9K10	467 15 019 0	LAGERBUCHSE	5C10 5G10
			367 31 017 4	WELLE KPL.	4G8	396 11 106 3	GARNST.ROHR	9K12	467 15 020 0	WELLE, HINTEN	5C7 5G7
			367 31 018 0	SCHAUGLAS	9H6 9B6	396 11 107 0	GARNST.ROHR	9J12			
			367 31 019 0	BOLZEN	2F3 4K7	396 14 005 0	DICHTSCHEIBE	1C3			

Teile-Nr.	Benennung	Bildtafel	Teile-Nr.	Benennung	Bildtafel	Teile-Nr.	Benennung	Bildtafel	Teile-Nr.	Benennung	Bildtafel
467 15 021 0	OELROHR	6M3 6M8 6M12 7M3 7M3 7M8 7M11 9E6 9L6	893 06 654 7	ZYL.SCHR. M 2,6 X 6	785 787	992 02 357 7	LI.SENKSCHR.6KT 6F3 6F12 7G5 7G9 8D2 8G2 8G2 8G4	6F3 6F12 7G5 7G9 8D2 8G2 8G2 8G4 1J3	993 06 724 0	ZYL.SCHR. M 4 X 30	961
467 15 022 0	HALTER	6L3 6L8 7L8 7L11	893 06 695 0	ZYL.SCHR. M 3,5 X 8	681 6812 7C3 7D9	992 02 364 0	GEW.STIFT M 6 X 6	1J3	993 06 739 7	ZYL.SCHR. M 5 X 18	3L7
467 15 023 0	NADELSCHUTZ	8D2 8D4 8H2 8H4 8K3	893 06 716 7	ZYL.SCHR.M4X10	1J1	992 02 367 7	LI.ZYL.SCHRAUBE M 4 X 4	102	993 08 700 8	HALBRD.SCHR.	1C6 1C9
467 15 033 3	OELSCHLAUCH	6L3 6M8 6M11 7L3 7M8 7M11	893 21 105 8	FEDERRING	3K8	992 02 380 0	ZYL.SCHRAUBE M 6 X 12	2H3	993 11 094 7	LI.SENKSCHR. M 3 X 6	8J3
467 15 042 0	HUELSE	5C11 5G11	893 52 072 0	GEW.STIFT M3X3 M 3 X 3	167 169 1H7 3F1 6B3 6B10 7D5 7D9	992 02 381 0	GEW.STIFT	8E1 8E3 8J1 8J3	993 11 523 0	LI.SENKSCHR. M 2 X 5	8D1 8H1 8D3 8H3
467 15 042 4	ZAHNRIEMENRAD	5B12 5F12	893 52 105 0	GEW.STIFT M 5 X 6	6E3 6E12 7E1 7F5 7G9 7F12	992 02 382 0	6KT.MUTTER M5 M 5	6E1 6E12 7G3 7G9	993 15 075 7	HALBRD.HOLZSCHR 3X20 3 X 20	9D6 9J6
467 16 001 3	HUBWELLE	3H9 3L9	893 52 117 0	GEW.STIFT M 6 X 10	4K12	992 02 389 0	SENKSCHR. M 4 X 9	4E1	993 15 116 0	HALBRD.HOLZSCHR 4 X 25	9B11
467 16 001 4	HUBWELLE	3H9 3L9	893 96 094 0	FL.KOPFSCHR. M 3 X 3	303	992 02 403 0	ZYL.SCHR.	3F5	993 19 034 7	SCHEIBE 3,2	7A3 7B9
467 16 003 0	ACHSE	2H2	894 45 038 8	FAECHERSCHEIBE 6,4	7F12	992 02 422 7	MUTTER	5B12 5F12	993 19 036 0	SCHEIBE 4,3	4B10
467 16 004 0	BUCHSE	2H1	894 45 037 8	FAECHERSCHEIBE 5,3 5,3	2B2 9D5 9J5	992 12 366 7	ZYL.SCHR. M 3 X 4	3F1 3G1	993 19 036 7	SCHEIBE 4,3	1B9 1C6 2D1 2G3
467 16 005 0	ZUGSTANGE	2J3	894 45 040 8	FAECHERSCHEIBE 8,4	2C12 2F12	993 03 134 7	SENKSCHR. M 4 X 6	6C3 6C9 7D5 7E7	993 19 037 7	SCHEIBE 5,3	7B3 7B9 9H12
467 16 005 4	HEBEL A.ACHSE	2J3	894 45 136 8	STERNFEDER	4J11	993 03 175 7	SENKSCHR. M 6 X 8	9D11	993 19 038 7	SCHEIBE 6,4	
467 16 006 0	BOLZEN	2K3	894 58 243 0	SENKBLECHSCHR. 4,2 X 16	9C7 9J7	993 03 724 7	SENKKOPFSCHR. M 3 X 6	5G11-5G11	993 19 038 7	SCHEIBE 6,4	9L10
467 16 006 4	KLOBEN	2K3	907 01 006 0	AUSGLEICHSSTUECK	9G12	993 03 765 7	SENKSCHR. M 4 X 8	1C7 1C9 1G8	993 19 040 7	SCHEIBE 8,4	9G12
467 16 007 3	VORSCHUBWELLE	3K1	907 01 007 0	AUSGLEICHSSTUECK	9F12	993 03 766 0	SENKSCHR. M 4 X 10	3C3	993 19 046 8	SCHEIBE 19	9M11
467 16 009 0	FEDERHAKEN	4E10	961 35 208 3	VERBINDUNGSMUTTER	9E9 9F9	993 03 766 7	SENKSCHR. M 4 X 10	1D7	993 25 048 7	FLUEGELMUTTER M 8	9G1
467 16 010 0	STOPFEN	3J9 3M9	968 86 068 0	O-RING	3G8	993 03 786 7	SENKKOPFSCHR. M 5 X 10	9G2 9G4	993 30 036 7	SCHEIBE 4,3	3C3
467 16 011 0	ABSTUETZUNG	3K8	968 96 042 7	FLACHKOPFSCHR. M 3 X 10	3G1	993 06 041 7	ZYL.SCHR. M 2 X 3	3E3 3E5	993 34 054 7	6KT.MUTTER M 3	9L3
467 16 012 0	SCHEIBE 804 NA	3J2	971 43 019 0	SCHEIBE	1D5	993 06 092 7	ZYL.SCHR. M 3 X 4	2C5	993 34 056 0	6KT.MUTTER M 4	2C9
	7-8,16		973 43 133 0	DRUCKFEDER	2B2	993 06 096 7	ZYL.SCHR. M 3 X 10	2B5 2C4	993 34 056 7	6KT.MUTTER M 4	1H3
467 16 013 0	SCHIEBEEEXZENTER	5C9 5D9	990 12 011 6	KEILRIEMEN 10 X 1165	9C10	993 06 132 7	ZYL.SCHR.M4X4 M 4 X 4	4H7 4K9	993 34 057 7	6KT.MUTTER M 5	1A6 1A9 1A10 2C3 3L7
467 16 023 0	STOPFEN	2H4	990 24 005 8	STAPA-MUFFE PG 11	9K12	993 06 135 0	ZYL.SCHR. M 4 X 8	2H3	993 34 058 7	6KT.MUTTER M 6	4F11 4D12 4E12 9B11
467 25 001 0	OELFANGMULDE	9C10	990 24 015 5	SCHUTZSTOPFEN TL-4-268	1B2	993 06 154 0	ZYL.SCHR.M5X6 M 5 X 6	4C9	993 41 120 8	RAENDELMU.POLY M 5	1B6 1B12 2B2
467 31 001 3	TRANSPORTFUSS-STANGE	4L9	990 24 016 0	VERSCHL.-STOPFEN	1C2 2B4 2B10	993 06 154 7	ZYL.SCHR. M 5 X 6	2G4	993 52 093 0	GEW.STIFT M 4 X 4	6C4 6D9 7D5 7F7
467 31 002 0	HEBEL	3E11	990 24 016 5	SCHUTZSTOPFEN TL-4-143	1B4	993 06 155 7	ZYL.SCHR.M5X8 M 5 X 8	2C7 4H9 9D5 9J5	993 52 094 0	GEW.STIFT M 4 X 5	1E7 1D9
467 31 002 3	NADELTR.HEBEL	3E11	990 43 091 1	FILZ WEISS 2X3X1000	8H2 8D2 8H4 8D4	993 06 177 7	ZYL.SCHR. M 6 X 12	9B10	993 52 095 0	GEW.STIFT M 4 X 6	1E7 1D9
467 31 002 4	NADELTR.HEBEL	3F10	990 81 003 8	ZUBEHOER KASTEN	9M9	993 06 654 0	ZYL.SCHR. M 2,6 X 6	7B5 7B7	993 52 103 0	GEW.STIFT M5X4 M 5 X 4	2H2 2H5 3K4 6E3 6F12 7G5-7G9
467 35 001 0	STOESSEL	9F9	990 81 006 1	SCHR.DREHER A 0,4 X 3,5	9K9	993 06 672 0	ZYL.SCHR. M 3 X 4	6F3	993 52 109 0	GEW.STIFT M 5 X 16	4F9 9E9
467 35 751 4	FADENSP.LUEFTUNG	9J1	992 01 314 0	ZYL.SCHR. M 8 X 13	2E12	993 06 676 7	ZYL.SCHR. M 3 X 10	9G3	993 52 111 0	GEW.STIFT M 5 X 20	6C3 6D12 7E4 7F9
467 36 001 3	MAGNETLEITUNG	9H7	992 01 658 0	ZYL.SCHR.	8C1 8C3 8G1 8G3	993 06 680 7	ZYL.SCHR. M 3 X 20	9M2	993 52 114 0	GEW.STIFT	4H10
467 36 002 4	OBERTEILEVERDRAHTUNG	9G3	992 02 356 0	LI.SENKSCHR. M 2 X 0,25 X 1	8C2 8G2 8C4 8G4						
467 36 003 3	ZWISCHENLEITUNG	9H3									
477 13 004 3	HEBEL	4D12									
477 16 022 3	KURBEL	3C5 3J11									
699 97 910 0	SCHL 2,5LWX1 PVC RAU	3L2 3C1 3F11 4H7 4H10 6L3 6M8 6M11 6D10 7F8 7L3 7M8 7L11 9C5 9C6 9D7 9B7 9H5 9J6 9H7 9K7 9B5									
699 97 910 4	SCHL 5 LWX1 PVC RAU	6M7 6K6 6K7 7K6 7K7 7M6 9D6 9C7 9E6 9B7 9J6 9H7 9J7 9L6									
699 98 925 0	RD3 GUMMI	2D3 2C6 2D8									
699 99 158 0	OELDOCHT.RD.1,5	3C1 3L3 3F11 4D8 4H7 4K7 4L7 4H10 9C5 9H5									
699 99 158 2	PFEIFENREINIGER RD.3	6D12 7F9									
699 99 158 7	OELDOCHT.RD.5	9D6 9J6									
893 03 765 6	SENKSCHR. M 4 X 8	2B4									

Teile-Nr.	Benennung	Bildtafel	Teile-Nr.	Benennung	Bildtafel	Teile-Nr.	Benennung	Bildtafel	Teile-Nr.	Benennung	Bildtafel
993 52 157 8	GEW.STIFT M 10 X 10	2J3	993 92 069 8	GEW.STIFT M 3 X 3	3F1	994 25 071 0	SCHEIBE 4	4H7	996 07 011 8	SICH.SCHEIBE 8	3B11 3G11
993 90 400 8	SCHRAUBENDREHER	3G5	993 92 085 8	GEW.STIFT	4K12	994 27 171 0	ZYL.KERBSTIFT 8 X 32	105	996 08 020 0	RILLENKUGELLAGER 16002	6C3 6C10 7E5 7E7
993 91 061 8	ZYL.SCHR. M 3 X 6	8D2 8D4 8H2 8H4 8K3	993 92 098 8	GEW.STIFT M 5 X 5	1E7 1E9	994 33 043 6	HALBRD.KERBNAG. 2 X 6	2J6	996 08 070 0	RILLENKUGELLAGER	6D1 6C3 6E3 6C10 6E10 6D12
993 91 063 8	ZYL.SCHR. M 3 X 10	3E1 3F1 3G1	993 92 099 8	GEW.STIFT M 5 X 6	1G1 1G2 2E5	994 33 075 0	HALBRD.KERBNAG. 3 X 8	2D3	996 08 230 0	RILLENKUGELLAGER 8X22X10,3	7D5 7F3 7G5 7D8 7G8 7F9
993 91 070 8	ZYL.SCHR. M 4 X 6	8D2 8J2 8L3 8D4 8J4	993 92 109 8	GEW.STIFT M 6 X 6	5C8 5G8	994 38 063 8	SPANNHUELSE 3 X 8	4E7	996 08 231 0	RILLENKUGELLAGER 4X14X6,7	1H1 1J2
993 91 080 7	ZYL.SCHR. M 4 X 8	7H6 9L3	993 92 110 8	GEW.STIFT M 6 X 8	1H5 1H6 1J5 1C5 1J6 4K12 5C9 5G9	994 39 601 0	MUTTER	4H11 4K12	996 08 232 0	KUGELLAGER	1H1
993 91 081 7	ZYL.SCHR. M 4 X 8	2D1 6F1 6F3 6F10 6F12 7H3 7H5 7G6 7G7 7H8 7H9 7G11	993 92 111 8	GEW.STIFT M 6 X 10	2E11 5B5 5F5 5B6 5F6	994 46 070 8	ZYL.SCHR. M 4 X 10	2B9 3B1 3L5	996 08 234 0	RILLENKUGELLAGER	6C1 6C10 3G8 6B10 6C1 7D3 7D8
993 91 081 8	ZYL.SCHR. M 4 X 8	2G2 7G10 9H3	993 92 122 8	GEW.STIFT M 8 X 12	1B5 4C7 5B12 5C12 5F12 5G12 1J5	994 46 100 8	ZYL.SCHR. M 5 X 10	4D7	996 08 629 0	RILLENKUGELLAGER	1H5
993 91 082 7	ZYL.SCHR. M 4 X 10	7H5 7J9	993 93 111 8	GEW.STIFT M 6 X 10	2F11 5C6 5G6	994 46 101 7	ZYL.SCHR. M 5 X 12	1J3	996 08 699 0	RILLENKUGELLAGER	1H4 1H6
993 91 082 8	ZYL.SCHR. M 4 X 10	2F11	993 93 112 8	GEW.STIFT M 6 X 12	5C12 5G12	994 46 101 8	ZYL.SCHR. M 5 X 12	4D7	996 10 106 8	SPRENGRING	1H3 1H6
993 91 083 7	ZYL.SCHR. M 4 X 12	3B3 3L2 3J10 3M10 6G3 6F10 6F12 7H5 7H8 7H9	993 93 133 8	GEW.STIFT M 8 X 16	8D1 8H1 8D3 8H3	994 46 102 8	ZYL.SCHR. M 5 X 16	4H8	996 28 384 0	DICHTRING A 10 X 14	4D12 4F12
993 91 083 8	ZYL.SCHR. M 4 X 12	4H11 4K11 7F1 7F12 7H11	993 94 075 8	GEW.STIFT NYLOK M 3 X 6	4H11	994 46 113 8	ZYL.SCHR. M 6 X 20	3L3	997 15 350 0	STECKHUELSE	9G3 9L2
993 91 088 8	ZYL.SCHR. M 4 X 25	6L3 6L8 6L11 7L3 7L11 7L8	993 94 111 8	GEW.STIFT M 6 X 10	1J1	994 46 111 8	ZYL.SCHR. M 6 X 12	3K5 3J11	998 83 031 8	HALBMONDRING H 15 X 1	3L2
993 91 102 8	ZYL.SCHR. M 5 X 10	2G5	993 95 070 8	GEW.STIFT M 3 X 4		994 46 534 8	ZYL.SCHR. M 5 X 12	2B5 2B8 4L7	998 85 226 0	SIMMERRING 12X22X4	2B10 5F10
993 91 104 8	ZYL.SCHR. M 5 X 16	9J9	993 95 294 8	GEW.STIFT	4L7	994 80 146 7	SCHEIBE B 6,4	9A10 9C11	998 85 680 0	SIMMERRING 20X30X7	2K1
993 91 105 8	ZYL.SCHR. M 5 X 18	4G9	993 96 042 7	FL.KOPFSCHR. M 2 X 2	3D3	995 11 021 0	VERSCHLUSZSCHR. CM 10 X 1	1E3	998 85 690 0	SIMMERRING 20X32X7	5B6 5F6
993 91 108 7	ZYL.SCHR. M 5 X 25	7B3 7B9	993 99 170 0	FL.KOPFSCHR. M 5 X 6	1B8 1A10	995 34 061 8	6KT.MUTTER PG 11 X 9	9M11	998 85 780 0	SIMMERRING 20X47X7	2K2
993 91 123 7	ZYL.SCHR. M 6 X 12	7G12	993 99 191 0	FL.KOPFSCHR. M 6 X 8	4C12	996 01 096 8	SICH.RING 20 X 1,2	1G5 1H6	998 85 940 0	SIMMERRING 22X32X5,5 22X32X3,5	6F1 6F12 7H3 7H9
993 91 123 8	ZYL.SCHR. M 6 X 12	4D12	994 04 154 7	ZYL.SCHR. M 5 X 25	3J8 3L7	996 01 098 8	SICH.RING 22 X 1,2	5B11 5F11	998 86 047 0	O-RING 9,5 X 1,6	8D2 8H2 8D4 8H4
993 91 124 8	ZYL.SCHR. M 6 X 16	3G10 4C9 4C11	994 04 176 8	6KT.SCHR. M 5 X 8	2L3	996 01 303 8	SICH.RING 18 X 1,5	9L11	998 86 053 0	O-RING 10 X 2	6E1 6E12 7F3 7G8
993 91 125 8	ZYL.SCHR. M 6 X 18	7H8	994 04 180 8	6KT.SCHR. M 5 X 16	4E9 9E9	996 02 115 8	SICH.RING 26 X 1,2	6E3 6E10 7G5 7G8	998 86 067 0	O-RING 11,3 X 2,4	5C6 5G6
993 91 126 8	ZYL.SCHR. M 6 X 20	2H6 3E11 4G9 4C12	994 04 184 8	6KT.SCHR. M 5 X 25	4C9	996 03 111 8	TELLERFEDER 12,8	3J4	998 86 159 0	O-RING 19 X 4	2E5
993 91 127 8	ZYL.SCHR. M 6 X 22	3M11 6M1 6K2 6L4 6M5 6L7 6M7 6K10 6M10 7K2 7M2 7L4 7M5 7L7 7M7 7K10 7M10	994 04 212 7	6KT.SCHR. M 6 X 20	3M11	996 03 182 8	TELLERFEDER 8 12,5	6E1 6E10 7G3 7G9	998 86 330 0	O-RING 38 X 2	6D3 6D10 7F5 7F7
993 91 149 8	ZYL.SCHR. M 8 X 30	3B5	994 04 214 8	6KT.SCHR. M 6 X 25	2K3	996 07 006 8	SICH.SCHEIBE 3,2	2E5 7F1 7H11 9G1	998 88 012 0	STUETZSCHEIBE 15X21X1,5	3B4
993 91 181 7	ZYL.SCHR. M 10 X 40	1E5	994 05 036 0	6KT.MUTTER M 4	4B10	996 07 007 8	SICH.SCHEIBE 4	1D9 1E7 2G3 3H9 3L9 6C1 6C12 7E1 7D2 7D3 7G6 7E9 7F10 7G10	998 88 104 0	PASZSCHEIBE 5X10X0,3	2D4
			994 05 036 7	MUTTER M 4	3K8	996 07 008 8	SICH.SCHEIBE 5	2C3 3J4 3K6 3H11 3H12 4B8 5B7 5E7 5B9 5F9	998 88 107 0	PASZSCHEIBE 7X13X0,3	3K5 3H12
			994 05 037 7	6KT.MUTTER M 5	4B9 9H11	996 07 010 8	SICH.SCHEIBE 7	1B5 4B8	998 88 162 0	PASZSCHEIBE 15X21X0,5	3L2 6D3 6D10 7E5 7F7
			994 05 038 7	6KT.MUTTER M 6	9L10				998 95 022 8	L-RING 28 X 1,2	6C3 6C10 7D5 7D8
									999 14 034 4	ISOLIERSCHL.GR	6M3 6L8 6L11 7M3 7L8 7L11

Teile-Nr.	Benennung	Bildtafel	Teile-Nr.	Benennung	Bildtafel
999 19 024 5	PLASTIKFLASCHE D 50/25	6M3 6M8 6M11 7M3 7M8 7M11			
999 20 115 4	ROHRSCHELLE 604-4	4H7 7H7 9M3			
999 20 120 5	NAGELSCHELLE ISO 7-11	9D6 9J6			
999 20 151 7	MAGNET	9H3			
999 20 152 8	DURCHFUEHRUNGSTUELLE	9A11			
999 20 156 8	GERAETEDOSE	964			
999 20 157 3	MAGNET	7A11 767 7612			
999 20 157 7	LEITUNGSVERT.	963 9M2			
999 20 158 1	MESSERKONTAKT	9H3 9H7			
999 20 160 0	STECKHUELSE	963 9L7			
999 21 083 4	DICHTRING	3K5 3L6 3H10 3L11			
999 21 083 9	SINTERBUCHSE	264			
999 22 069 4	SCHLAUCHKLEMME 0507/3	3K4			
999 22 071 0	SAUGVENTIL 100.104	6M3 6M8 6M11 7M3 7M8 7M11 9D7 9K7			
999 23 051 8	DICHTRING G15X21X3	6D1 6D4 6C9 6D12 7F5 7F3 7F7 7E9			
999 24 037 6	T-STUECK 199.445	6M6 7M6			

Teilenummern neu hinzu 26. 1. 2000

0068	008420	Oberteilstuetze	9G11	0467	150094	Greifer K	6G2, 6G11, 7J3, 7J8
0077	110220	Auflage	9H9	0467	310050	Kloben	3G10
0077	110230	Zentrierstueck	9G10	0467	310293	Hebel	3E11
0105	310143	Stelling	10F6	0467	367999	HP 13-9 (Pn.-Hubverst.)	10A3
0167	150270	Spule	6H3, 6H11, 7K3, 7K8	0568	330100	Bundbuchse	4C8
0216	000134	Senkschr.	1E1	0699	979100	Schlauch	10B4, 10B5, 6J3, 6J8, 6J11, 7J2, 7J7, 7K11
0245	001660	ASpule	6H3, 6H11, 7K3, 7K8	0767	150010	Rolle	7G10
0291	000159	Fadenführung	3F3	0767	150014	Greiferlager K	6E9
0296	150013	Lager V	1B5	0767	150024	Greiferlager K	6E4
0367	100414	Armdeckel K	10A2	0767	150034	Greiferlager K	7J10
0367	120213	Fadeneose	9B9	0767	150044	Greiferlager K	7G2
0367	120303	Klemmkloben	10G3	0767	150050	Oelfangring	6B3, 6B10
0367	130600	Druckfeder	4C7	0767	150060	Scheibe	6C3, 6C10
0367	130710	Huelse	4C7	0767	150070	Scheibe	6C3, 6C10
0367	130720	Stange	4C7	0767	150143	Spannrolle V	1C5
0367	150823	Exz. Welle	6B12, 6C3	0767	150144	Spannrolle VK	1C5
0367	151040	Filtertopf	6J3, 6J8, 6J11, 7J2, 7J7, 7J11, 7K11	0767	150150	Bolzen	1D5
0367	151050	Hülse	6J3, 6J8, 6J11, 7J2, 7J7, 7K11	0767	150230	Filtertasche	6J2, 6J7, 6J10, 7J1, 7J6, 7K10
0367	310330	Buchse	10G6	0767	150234	Filter K	6J3, 6J8, 6J11, 7J2, 7J7, 7J11
0367	310380	Bolzen	10F1	0791	001081	Garnst. Rohr (lang)	9K12
0367	310410	Klemmstück	10E1, 10G2	0791	001085	Garnstaender Rohr	9K11
0367	310433	Exz. Körper K	10G2	0791	001086	Garnst. Rohr	9J11
0367	310443	Schieber	10G3	0791	001088	Garnst. Rohr (geteilt)	9M11
0367	310450	Schalbuchse	10E4	0791	001091	Garnhaltearm	9H9
0367	310453	Schalbuchse	10E4	0791	001093	Scheibe	9H9
0367	310460	Buchse	10F4	0791	001093A	Scheibe	9G9
0367	310473	Schaltring	10G5	0791	001094	Linsenschr.	9G9, 9H9
0367	310480	Bolzen	10D4, 10F5	0791	001095	Mutter	9F9, 9H10
0367	310490	Filzscheibe	10E5	0791	001096	Fadenfuehr. K	9G10
0367	310500	Scheibe	10F6	0797	002214	T-Verbindung	6K3, 6K8, 6K11, 7K2, 7J7, 7K11
0367	310513	Klemmring	10E4	0801	411280	Druckfeder	10E3
0367	310520	Bolzen	10G2	0893	520720	Gew. Stift	10C5
0367	310530	Zugstange	10E3, 10G4	0893	521140	Gew. Stift	10F6
0367	310540	Bolzen	10E4, 10F3	0907	010050	Obert. Auflage	9F12
0367	310550	Ausrückhebel	10D4	0933	000587	Tellerfeder	6E1, 6E10, 7G3, 7G9
0367	310554	Ausrückhebel	10D4	0973	421362	Zyl. Stift	10F2
0367	310560	Halteblech	10D5	0990	240057	Muffe	9K11
0367	310570	Zugstange	10D4	0990	254269	Knieschalter	10J5
0367	310583	Kugelpfanne	10B4	0993	037220	Senkschraube	5G11, 5D11
0367	310590	Brücke	10C4	0993	190467	Scheibe	9L11, 9L12
0367	310600	Stift	10D7	0993	526160	Gew. Stift	10G2
0367	310633	Lagerstück V	10H6	0994	330430	Halbrd. Kb. Nagel	10E5
0367	310640	Stopfen	10B4	0994	380638	Spannhuelse	4B7
0367	310650	Oelrohr	10B4	0995	340617	6kt. Mutter	9L11, 9L12
0367	310664	Exzenter K	10E1	0996	070088	Sich. Scheibe	4B7
0367	310680	Stift	10G3	0996	120360	Stelling	10C5
0367	310700	Gleitstein	10F1	0998	861590	O-Ring	9D12
0367	310710	Winkel	10C7	0998	910438	Sprengring	10F6
0367	310723	Stellschr.	10D7	0999	190245	Plastikflasche	9H12
0367	310730	Exzenter	10F1	0999	200437	Kabeltülle	10C7
0367	311343	Zugstange	3G12	0999	220512	Ventil	10J3
0367	350023	Buegel V	9E10	0999	220705	Anschlussplatte	10K3
0396	140050	Dichtscheibe	10B5	0999	220710	Ventil	6J3, 6J8, 6J11, 7J2, 7J7, 7K11
0396	170160	Fadenfuehrung	2B2	0999	220770	Zylinder, doppel	10C5
0396	170170	Gew. Bolzen	2B3	0999	240302	Doppelnippel	10K1
0467	120090	Nadelstange	3E5	0999	240305	Vert. Block	10K1
0467	120094	Nadelstange K	3E5	0999	240397	T-E Verschr.	10J3
0467	130340	Federfuehrung	4C7	9120	010300	Rillenkugellager	10G6
0467	130354	Druckfeder	4A7	9202	001688	Zyl. Schr.	10E4
0467	150084	Spulengehäuse V	6G2, 6G11, 7J3, 7J8	9202	002058	Zyl. Schr.	10C7, 10D6

9202 002068	Zyl.Schraube	6F1, 6F10, 6F12, 6F3, 7H3, 7H5, 7H8, 7H9
9202 002087	Zyl. Schr.	10G3
9202 002088	Zyl. Schr.	3L2
9202 002088	Zyl.Schraube	3L2, 6F10, 6F12, 6G3, 7H5, 7H8,7H9
9202 002478	Zyl. Schr.	10J3
9202 003307	Zyl. Schraube	9E10
9202 042488	Zyl. Schraube	1B1, 2C6, 2C8
9202 042888	Zyl. Schr.	3K5
9202 042908	Zyl. Schr.	3L3
9203 004277	Zyl. Schraube	9A11
9203 312411	Senkschr.	3E3
9203 313961	Senkschr.	10C7
9205 024010	Gew. Stift	10B4
9205 101528	Gew. Stift	3G5
9205 101918	Gew. Stift	10D6, 10E2
9205 102158	Gew. Stift	7G5, 7G9
9205 102168	Gew. Stift	2D5
9205 102478	Gew. Stift	10E3
9205 102488	Gew. Stift	10E2
9231 000377	6kt. Mutter	10C3
9231 000397	6kt. Mutter	10C3, 10C4
9231 110128	6kt. Mutter	10C7
9234 000067	6kt. Mutter	10D6, 10E1, 10G2
9301 101921	Zyl. Stift	10F3
9301 102283	RGKPF. Zyl. Stift	10G6
9330 000087	Scheibe	10E6, 10G3
9330 000108	Scheibe	10C7
9330 000127	Scheibe	9E10
9330 900117	Scheibe	9A11
9334 000040	Paszscheibe	3J2
9352 000200	Sich. Ring	10F6
9352 000300	Sich. Ring	10F6
9357 000060	Sich. Scheibe	10D4, 10E3, 10G4
9357 000070	Sich. Scheibe	3J4
9357 000080	Sich. Scheibe	1B5
9357 200052	Kugelzapfen	10C4
9357 200103	Kugelpfanne	10B4
9710 061110	Ventil, Magnet	10K3
9710 981010	Schalldämpfer	10L3
9710 982005	Schalldämpfer	10J3
9731 005004	Schlauch	10H1
9731 006004	Schlauch	10K1
9790 000400	Stecknippel	10K3
9790 101010	L-Schw. Verschr.	10B5
9790 200000	Verschr. Gd	10B5
9790 201001	Verschr. Wi-E	10H1
9840 104205	Flachst. Hülse	10K4
9840 104212	Schutzhülse	10L5
9840 111003	Flach. H.-Band	10M4
9840 120001	Nagelschelle	10J5
9840 120103	Kabelhalter	9D10
9840 121002	Kabelbinder	6K2, 6K7, 6K10, 7K1, 7J6, 7K11
9840 123002	Stahlnadel	10J5
9840 136002	Verschl. Stopfen	10A2
9840 301052	Leitung	10L5
9870 001105	Leitung K	10M4

Näheinrichtungen Sewing Equipment

467-65

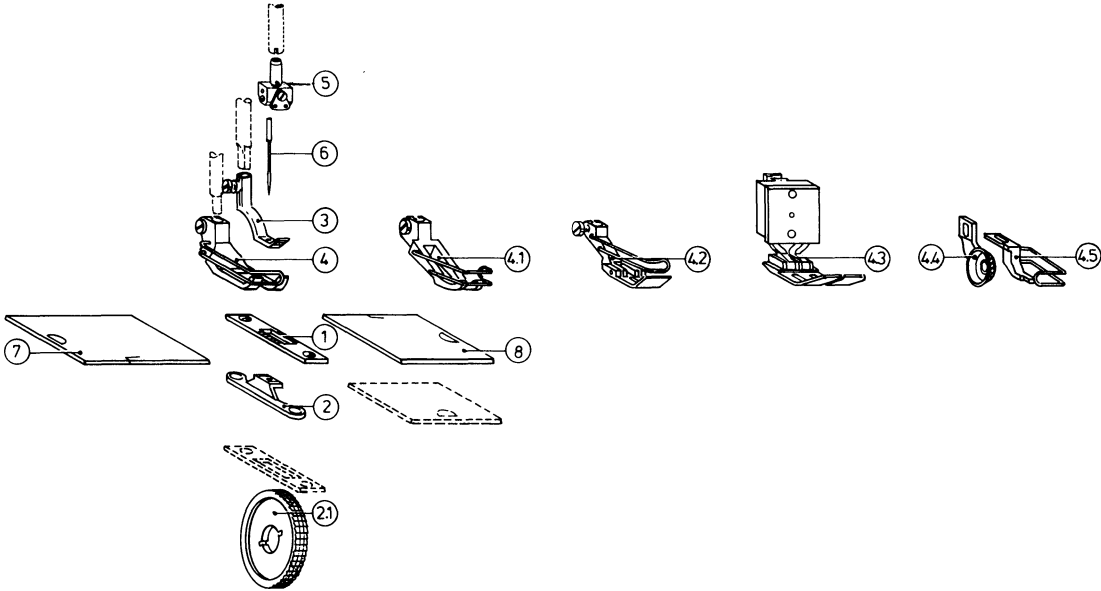

① Stichplatte	① Needle plate	① Plaque à aiguilles	① Placa de aguja
② Transporteur	② Feed	② Transporteur	② Transportador
②.1 Radtransporteur	②.1 Roller feed	②.1 Roue à transport	②.1 Transportador de rueda
③ Transportfuß	③ Feed foot	③ Pied transporteur	③ Pie transportador
④ Fester Fuß (Drückerfuß)	④ Fixed foot	④ Pied transporteur (presseur)	④ Pie fijo (pie prensatela)
④.1 Fester Fuß (Kletterfuß)	④.1 Climbing foot	④.1 Pied transporteur (grimpeur)	④.1 Pie fijo (pie trepador)
④.2 Gelenkfuß	④.2 Hinged foot	④.2 Pied articulé	④.2 Pie articulado
④.3 Ausgleichfuß	④.3 Equalising foot	④.3 Pied égalisateur	④.3 Pie compensador
④.4 Rollfuß	④.4 Roller foot	④.4 Pied à roulettes	④.4 Pie de rodillo
④.5 Niederhalter	④.5 Press pad	④.5 Presse-tôle	④.5 Aprieta-cuero
⑤ Nadelhalter	⑤ Needle holder	⑤ Support de l'aiguille	⑤ Suporte de aguja
⑥ Nadel	⑥ Needle	⑥ Aiguille	⑥ Aguja
⑦ Schieber links	⑦ Left-hand slide plate	⑦ Poussoir de gauche	⑦ Placa corrediza izquierda
⑧ Schieber rechts	⑧ Right-hand slide plate	⑧ Poussoir de droite	⑧ Placa corrediza derecha

2. NA ≙ Nahtabstand 

NA ≙ seam spacing 

NA ≙ distance entre deux coutures 

NA ≙ distancia entre costuras 











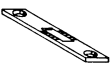





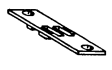

3. Zuordnung der Nadelstärke zu den Unterklassen

Relationship of needle thickness to the sub-classes

Relation entre la grosseur d'aiguille et les différentes sous-classes

Agregación del grosor de aguja a los submodelos

Nadelstärke	Unterklassen 467-65						
-	-	-	-	-	-	-	-
110 - 140	-	- 63	- 263	- 73	- 373	- 273	-
140 - 180 (200)	-	- 64	- 264	- 74	- 374	- 274	-

Zeile	E-Nr.	467-65	NA									Transporteur- Breite „A“ = mm
01	K467E1	-373/N6 FA-373/N6	467 20 009 0	467 21 006 0	467 22 001 3	367 22 099 3	467 12 009 4	134-35/ 130	467 14 002 0	467 14 002 0	8 mm	
02	K467E2	-373/N9 FA-373/N9	467 20 002 0	467 21 006 0	467 22 001 3	467 22 004 3	467 12 009 4	134-35/ 130	467 14 002 0	467 14 002 0	8 mm	
03		-73H12/N6 FA-73H12/N6	367 20 003 0	467 21 004 0	367 22 020 3	367 22 098 3	467 12 009 4	134-35/ 130	467 14 002 0	467 14 002 0	6 mm	
												
04	K467E3	-373/N6 FA-373/N6	367 20 003 0	467 21 004 0	367 22 020 3	367 22 142 3	467 12 009 4	134-35/ 130	467 14 002 0	467 14 002 0	6 mm	
05	K467E4	-373/N9 FA-373/N9	367 20 020 0	467 21 004 0	367 22 020 3	367 22 142 3	467 12 009 4	134-35/ 130	467 14 002 0	467 14 002 0	6 mm	
												
06		-73/N6 FA-73/N6	367 20 003 0	467 21 004 0	367 22 020 3	367 22 004 3	467 12 009 4	134-35/ 130	467 14 002 0	467 14 002 0	6 mm	
												
07		-273/N6 FA-273/N6	25 467 20 234 0	467 21 234 0	367 22 320 3	367 22 246 3	467 23 218 4	134-35/ 120	467 14 201 0	467 14 201 0		
08	K467E20/4	-273/N6 FA-273/N6	4 467 20 212 0	467 21 211 0	067 22 232 3	367 22 247 3	467 23 205 4	134-35/ 120	467 14 201 0	467 14 201 0		
09		-273/N6 FA-273/N6	5 467 20 224 0	467 21 221 0	067 22 233 3	367 22 224 3	467 23 210 4	134-35/ 120	467 14 201 0	467 14 201 0		
10	K467E20/6	-273/N6 FA-273/N6	6 467 20 204 0	467 21 206 0	067 22 234 3	367 22 209 3	467 23 201 4	134-35/ 120	467 14 201 0	467 14 201 0		
11	K467E20/8	-273/N6 FA-273/N6	8 467 20 209 0	467 21 208 0	067 22 235 3	367 22 210 3	467 23 203 4	135-35/ 120	467 14 203 0	467 14 203 0		
12	K467E20/10	-273/N6 FA-273/N6	10 467 20 216 0	467 21 214 0	067 22 238 3	367 22 201 3	467 23 207 4	134-35/ 120	467 14 203 0	467 14 203 0		
13	K467E20/12	-273/N6 FA-273/N6	12 467 20 206 0	467 21 207 0	067 22 239 3	367 22 231 3	467 23 202 4	134-35/ 120	467 14 202 0	467 14 202 0		
14	K467E20/14	-273/N6 FA-273/N6	14 467 20 221 0	467 21 219 0	067 22 241 3	367 22 232 3	467 23 209 4	134-35/ 120	467 14 202 0	467 14 202 0		
15	K467E20/16	-273/N6 FA-273/N6	16 467 20 210 0	467 21 209 0	067 22 242 3	367 22 233 3	467 23 204 4	134-35/ 120	467 14 204 0	467 14 204 0		
16		-273/N6 FA-273/N6	18 467 20 219 0	467 21 217 0	067 22 243 3	367 22 253 3	467 23 208 4	134-35/ 120	467 14 204 0	467 14 204 0		
17	K467E20/20	-273/N6 FA-273/N6	20 467 20 215 0	467 21 213 0	067 22 244 3	367 22 254 3	467 23 206 4	134-35/ 120	467 14 205 0	467 14 205 0		
18	K467E20/22	-273/N6 FA-273/N6	22 467 20 218 0	467 21 240 0	067 22 277 3	367 22 241 3	467 23 221 4	134-35/ 120	467 14 205 0	467 14 205 0		
19	K467E20/24	-273/N6 FA-273/N6	24 467 20 228 0	467 21 229 0	067 22 245 3	367 22 316 3	467 23 220 4	134-35/ 120	467 90 006 9	467 90 006 9		
20		-273/N9 FA-273/N9	5 467 20 239 0	467 21 221 0	067 22 233 3	367 22 267 3	467 23 210 4	134-35/ 120	467 14 201 0	467 14 201 0		
21	K467E21/6	-273/N9 FA-273/N9	6 467 20 205 0	467 21 206 0	067 22 234 3	367 22 257 3	367 23 209 4	134-35/ 120	467 14 201 0	467 14 201 0		
22		-273/N9 FA-273/N9	8 467 20 223 0	467 21 208 0	067 22 235 3	367 22 277 3	467 23 203 4	134-35/ 120	467 14 203 0	467 14 203 0		
23	K467E21/10	-273/N9 FA-273/N9	10 467 20 243 0	467 21 214 0	467 22 238 3	367 22 343 3	367 23 202 4	134-35/ 120	467 14 203 0	467 14 203 0		
24	K467E21/12	-273/N9 FA-273/N9	12 467 20 207 0	467 21 207 0	067 22 239 3	367 22 258 3	367 23 205 4	134-35/ 120	467 14 202 0	467 14 202 0		
25	K467E21/14	-273/N9 FA-273/N9	14 467 20 230 0	467 21 219 0	067 22 241 3	367 22 300 3	367 23 215 4	134-35/ 120	467 14 202 0	467 14 202 0		
26		-273/N9 FA-273/N9	18 467 20 241 0	467 21 217 0	067 22 243 3	367 22 340 3	467 23 208 4	134-35/ 120	467 14 204 0	467 14 204 0		
27	K467E21/20	-273/N9 FA-273/N9	20 467 20 214 0	467 21 213 0	067 22 244 3	367 22 270 3	467 23 206 4	134-35/ 120	467 14 205 0	467 14 205 0		
28	K467E21/24	-273/N9 FA-273/N9	24 467 20 240 0	467 21 229 0	067 22 245 3	367 22 339 3	467 23 220 4	134-35/ 120	467 90 006 9	467 90 006 9		

Zeile	E-Nr.	467-65	NA										
29	K467E22/10	-273/N9 FA273/N9	10	467 20 244 0	467 21 248 0	467 22 211 3	467 22 212 3	467 23 224 4	134-35/ 120	467 14 205 0	467 14 002 0		
30	K467E22/12	-273/N9 FA273/N9	12	467 20 247 0	467 21 252 0	467 22 217 3	467 22 218 3	467 23 228 4	134-35/ 120	467 90 006 9	467 14 002 0		
31	K467E22/14	-273/N9 FA273/N9	14	467 20 245 0	467 21 249 0	467 22 213 3	467 22 214 3	467 23 225 4	134-35/ 120	467 14 209 0	467 14 002 0		
32	K467E23/14	-FA-273/N9	14	467 20 253 3	467 21 219 0	067 22 241 3	367 22 300 3	367 23 215 4	134-35/ 120	467 14 202 0	467 14 202 0		
33	K467E24/14	-FA-273/N9	14	467 20 250 3	467 21 249 0	467 22 213 3	467 22 214 3	467 23 225 4	134-35/ 120	467 14 209 0	467 14 002 0		
467-65-BNF1- (von 26-50 mm)													
32		-273/N6	26	367 20 243 0	367 21 254 0	067 22 413 3	367 22 255 3	467 23 216 4	134	467 90 006 9	467 90 006 0		
33		-273/N6	30	367 20 233 0	367 21 253 0	067 22 380 3	367 22 240 3	467 23 214 4	134	467 14 209 0	467 14 209 0		
34		-273/N6	32	467 20 229 0	467 21 230 0	067 22 401 3	367 22 218 3	467 23 215 4	134	467 14 210 0	467 14 210 0		
35		-273/N6	38	467 20 235 0	467 21 235 0	067 22 364 3	367 22 321 3	467 23 219 4	134	467 14 212 0	467 14 212 0		
36		-273/N6	50	467 20 220 0	467 21 218 0	067 22 392 3	367 22 276 3	467 23 213 4	134	467 14 208 0	467 14 208 0		
467-65-BNF2- (von 51-75 mm)													
37		-273/N6	54	467 20 242 0	467 21 246 0	067 22 204 3	367 22 342 3	467 23 223 4	134	467 14 214 0	467 14 214 0		
38		-273/N6	60	467 20 217 0	467 21 215 0	067 22 414 3	367 22 274 3	467 23 222 4	134	467 14 213 0	467 14 213 0		
39		-273/N6	70	467 20 233 0	467 21 232 0	067 22 368 3	467 22 205 3	467 23 217 4	134	467 14 211 0	467 14 211 0		
467-65-BNF3- (von 76-90 mm)													
40		-273/N6	80	467 20 227 0	467 21 224 0	467 22 201 3	467 22 202 3	467 23 212 4	134	467 14 207 0	467 14 207 0		
41		FA-273/N6	90	467 90 007 1	467 21 225 0	467 90 007 3	467 90 007 4	467 90 010 2	134	467 90 007 8	467 90 007 8		
42		-274/N6 FA-274/N6	12	467 20 206 0	467 21 233 0	067 22 239 3	367 22 231 3	467 23 202 4	134	467 14 202 0	467 14 202 0		
43		-274/N6 FA-274/N6	14	467 20 221 0	467 21 237 0	067 22 241 3	367 22 232 3	467 23 209 4	134	467 14 202 0	467 14 202 0		
44		-274/N6 FA-274/N6	16	467 20 210 0	467 21 223 0	067 22 242 3	367 22 233 3	467 23 204 4	134	467 14 204 0	467 14 204 0		
45		-274/N6 FA-274/N6	18	467 20 219 0	467 21 238 0	067 22 243 3	367 22 340 3	467 23 208 4	134	467 14 204 0	467 14 204 0		
46		-274/N6 FA-274/N6	24	467 20 228 0	467 21 239 0	067 22 245 3	367 22 316 3	467 23 220 4	134	467 90 006 9	467 90 006 9		

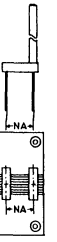

		(Bei Nähmaschinen bis 6 mm Stichlänge muß die Buchse im Maschinenarm auf 6 mm zurückgestellt werden.)										
E 1		Nähmaschine für allgemeine Näharbeiten in mittelschwerem Nähgut für die Polster-, Planen-, Markisen- und Campingartikelfabrikation, Nadelstärke Nm 110-140, Stichlänge max. 6 mm					Sewing equipment for general stitching in the production of upholstery, awnings, tarpaulins and camping articles, needle sizes Nm 110-140, stitch length up to 6 mm					
E 2		Nähmaschine für allgemeine Näharbeiten in mittelschwerem Nähgut für die Polster-, Planen-, Markisen- und Campingartikelfabrikation, Nadelstärke Nm 110-140, Stichlänge max. 9 mm					Sewing equipment for general stitching in the production of upholstery, awnings, tarpaulins and camping articles, needle sizes Nm 110-140, stitch length up to 9 mm					
		Nähmaschine für Polsterarbeiten in mittelschwerem Nähgut mit Schiffchenfuß zum Durchsteppen für stark wattiertes Nähgut, Nadelstärke Nm 110-140, Stichlänge max. 6 mm					Sewing equipment for upholstery in medium weight material with special foot and narrow attachment, for stitching and quilting extremely padded material, needle sizes Nm 110-140, stitch length up to 6 mm					
E 4		Nähmaschine für Polsterarbeiten in mittelschwerem Nähgut mit Schiffchenfuß zum Durchsteppen für stark wattiertes Nähgut, Nadelstärke Nm 110-140, Stichlänge max. 9 mm					Sewing equipment for upholstery in medium weight material with special foot and narrow attachment, for stitching and quilting extremely padded material, needle sizes Nm 110-140, stitch length up to 9 mm					
	E 20/4	Zweinadel-Nähmaschine für allgemeine Näharbeiten in mittelschwerem Nähgut für die Polster-, Planen-, Markisen- und Campingartikelfabrikation, Nadelabstand 4 mm, Nadelstärke Nm 110-140, Stichlänge max. 6 mm					2 needle sewing equipment for general stitching in the production of upholstery, awnings, tarpaulins and camping articles, seam distance 4 mm, needle sizes Nm 110-140, stitch length up to 6 mm					
	E 20/6	Zweinadel-Nähmaschine für allgemeine Näharbeiten in mittelschwerem Nähgut für die Polster-, Planen-, Markisen- und Campingartikelfabrikation, Nadelabstand 6 mm, Nadelstärke Nm 110-140, Stichlänge max. 6 mm					2 needle sewing equipment for general stitching for the production of upholstery, awnings, tarpaulins and camping articles, seam distance 6 mm, needle sizes Nm 110-140, stitch length up to 6 mm					
	E 20/8	Zweinadel-Nähmaschine für allgemeine Näharbeiten in mittelschwerem Nähgut für die Polster-, Planen-, Markisen- und Campingartikelfabrikation, Nadelabstand 8 mm, Nadelstärke Nm 110-140, Stichlänge max. 6 mm					2 needle sewing equipment for general stitching for the production of upholstery, awnings, tarpaulins and camping articles, seam distance 8 mm, needle sizes Nm 110-140, stitch length up to 6 mm					

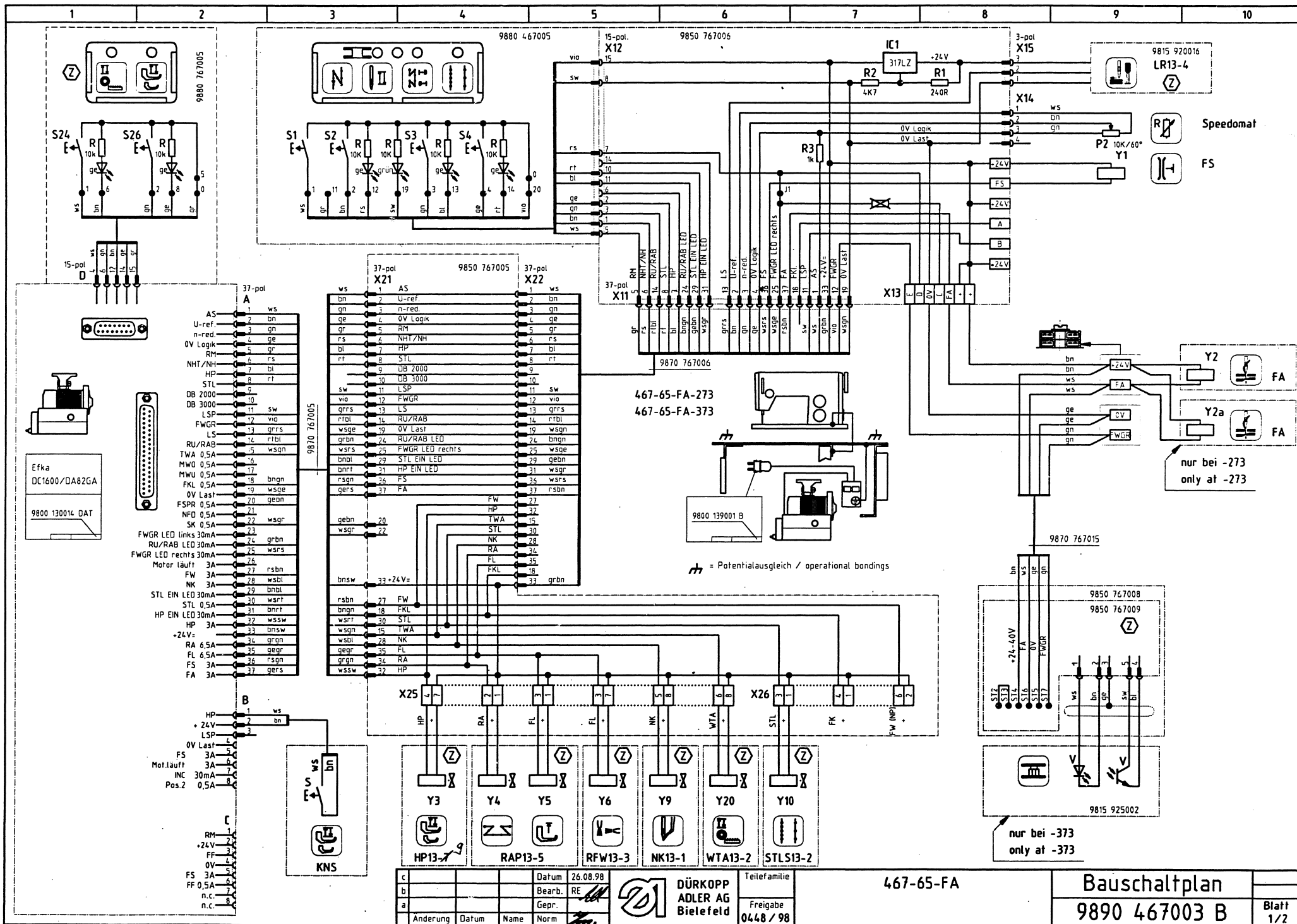

c		Datum	26.08.98
b		Bearb.	RE
a		Gepr.	
	Anderung	Datum	Name

DÜRKOPP ADLER AG
 Bielefeld

Teilfamilie
 Freigabe
 0448 / 98

467-65-FA

Bauschaltplan
 9890 467003 B

Blatt 1/2

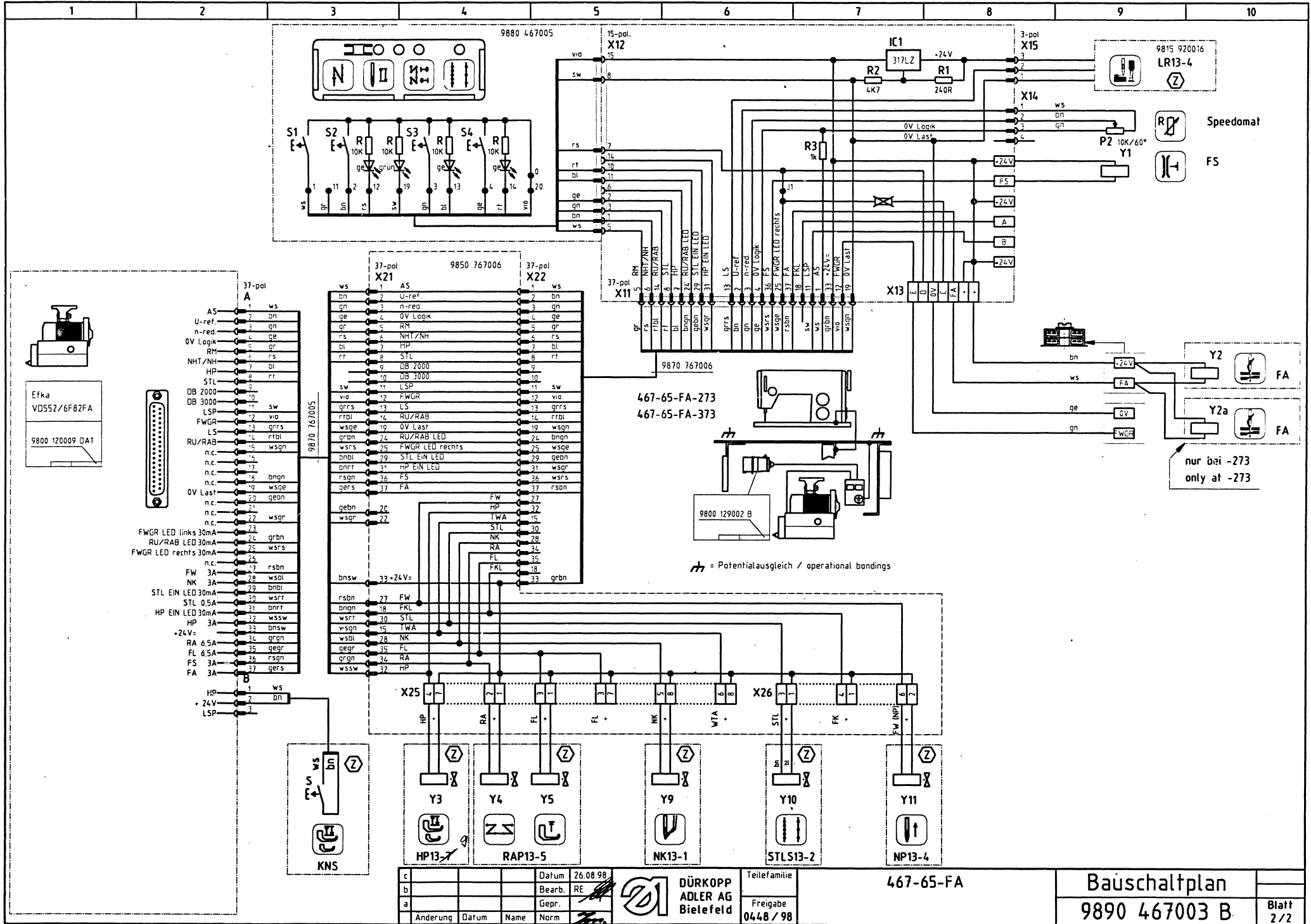

c		Datum	26.08.98
b		Bearb.	RE
a		Gepr.	
	Anderung	Datum	Name

DÜRKOPP ADLER AG
Bielefeld

Teilfamilie
Freigabe
0448 / 98

467-65-FA

Bauschaltplan
9890 467003 B

Blatt
2/2